

MANUAL

Smart Temperature Monitoring Relays

CM-TCN



۰۲۱-۶۶۱۷۲۰۳۲

www.sazehgostarsgp.com

@sazehgostar_paytakht

PREPARED 2022-11-15	STATUS Approved	SECURITY LEVEL Public		
APPROVED 2022-11-15	DOCUMENT KIND Manual			
OWNING ORGANIZATION ABB STOTZ-KONTAKT GmbH	DOCUMENT ID. 2CDC112285M0201	REV. E	LANG. en	PAGE 1/57

Important notice, purpose and basic description

This user manual supplements our product catalog and provides the general functionality as well as application suggestions for our smart temperature monitoring relays. For additional technical data please refer to our catalogue or contact us.

You can either read the entire manual or selectively gather information about individual devices and their possible applications.

The table of contents and the index section enable quick and easy access to the desired information.

Target group

This description is intended for use by trained specialists in electrical installation and control and automation engineering, who are familiar with the applicable national standards.

Safety requirements

The responsible staff must ensure that the application or use of the products described satisfies all the requirements for safety, including all the relevant laws, regulations, guidelines and standards.

Symbols

This technical document contains markers to point the reader to important information, potential risks and precautionary information. The following symbols are used:



Indicates a potentially dangerous situation that can cause damage to the connected devices or the environment.



Indicates important information and conditions.



Indicates a potentially dangerous situation that can cause human injuries.

Abbreviations

NFC	Near Field Communication
EPiC	Electrification Products intuitive Configurator
CM-TCN	Temperature monitoring relay

Related Documents

2CDC112286C0201	CM-TCN catalog
1SVC750040M0000	Installation instructions

STATUS	SECURITY LEVEL	DOCUMENT ID.	REV.	LANG.	PAGE
Approved	Public	2CDC112285M0201	E	en	2/57

Contents

1. Device overview	5
1.1. LCD display and symbol-based menu structure.....	5
1.2. Near Field Communication (NFC)	6
1.3. Device description.....	7
2. Installation	8
2.1. Mounting and de-mounting	8
2.2. Block diagram.....	8
2.3. Connection of resistance temperature detectors	9
2.3.1. 2-wire measurement.....	9
2.3.2. 3-wire measurement	10
2.3.3. CM-TCN wiring when used with PT1000 sensor(s)	10
2.4. Sealable transparent cover	12
3. Commissioning	12
3.1. Main screen	12
3.2. Menu navigation.....	14
4. Configuration and setup	15
4.1. Factory profiles	15
4.1.1. Factory 1: Motor protection with PT100 sensors	17
4.1.2. Factory 2: Motor bearing supervision with PT100	18
4.1.3. Factory 3: Motor supervision with PT100 – 2.....	19
4.1.4. Factory 4: Motor winding supervision with PTC.....	20
4.1.5. Factory 5: Transformer supervision with PT100.....	21
4.1.6. Factory 6: Transformer supervision with PTC.....	22
4.1.7. Factory 7: Individual temperature supervision with PT100.....	23
4.2. User profiles and individual parameterization	24
4.2.1. Step 1: Sensor configuration	24
4.2.2. Step 2: Signal definition	25
4.2.3. Step 3: Relay assignment and configuration	29
4.2.4. Save configuration into user profiles	33
5. Security	34
5.1. Parameter lock.....	34
5.2. Password protection.....	35
5.3. Near Field Communication	36
6. Additional functions	37
6.1. Display ON-time	37
6.2. Temperature unit	38
6.3. Power-on delay	38
6.4. User-defined text.....	38
7. Condition monitoring	39
7.1. Event history	40
7.2. Operating hours counter.....	41
7.3. Maintenance counter	41
7.4. Statistics.....	42
7.5. Password reset counter.....	42
7.6. Simulation mode.....	42
7.7. 2D code.....	43
7.8. Factory reset.....	43

7.9. Device information	44
8. Modbus communication (only CM-TCN.012).....	44
8.1. Electrical installation	44
8.2. Modbus configuration.....	45
8.3. Modbus RTU register map.....	46
8.3.1. Supported function codes.....	46
8.3.2. History and parameters reset, relays control.....	46
8.3.3. Status and measurements.....	47
8.3.4. Condition monitoring data: event history and timestamp.....	47
8.3.5. Condition monitoring data: operating hours counter, maintenance counter, statistics	48
8.3.6. Device configuration.....	49
8.3.7. Common settings.....	52
8.3.8. System information.....	53
9. Error handling.....	54
10. Software license information.....	55
11. Cyber security legal disclaimer	55

سازه گستر پایتخت

تامین کننده ملزومات برق

الکتریکال - مکانیکال - ابزار دقیق

۰۲۱-۶۶۱۷۲۰۳۲

www.sazehgostarsgp.com

@sazehgostar_paytakht

STATUS	SECURITY LEVEL	DOCUMENT ID.	REV.	LANG.	PAGE
Approved	Public	2CDC112285M0201	E	en	4/57

1. Device overview

The CM-TCN smart temperature monitoring relay aims to meet different customer needs with just one device. The LCD screen provides status updates at a single glance. Near Field Communication (NFC) enables to adjust settings with one touch of a smartphone, making installation faster and more intuitive. The device comes with a wide measuring range from -200...+850 °C and is compatible with multiple sensor types, as well as predefined settings for common motor or transformer supervision applications and storage space for user-defined settings.

With the ABB EPiC app wireless configuration and status checks are easily possible. By using the app parameter settings can be edited quickly, stored in the app or copied to other CM-TCN devices, even in an unpowered state. Moreover, parameters can be uploaded into a cloud or shared within seconds e.g. via E-mail.

The temperature monitoring relays are typically used in the following applications:

- Motor and system protection
- Temperature monitoring in control cabinets
- Monitoring of electrical motors
- Monitoring of transformers
- Ambient temperature monitoring
- Temperature limits for process variables
- Monitoring of bearing temperatures
- Monitoring of cooling liquids
- Packaging industry
- Air Conditioning Systems
- Ventilation systems
- Heat pumps
- Hot water supplies

1.1. LCD display and symbol-based menu structure

The display:

- allows the intuitive and fast configuration with the help of a symbol-based menu structure. Profiles are available for various applications. Each parameter can also be modified individually and stored as a user profile for later reuse.
- shows permanently the device status and all currently measured temperatures. Detailed diagnosis information helps to identify problems quickly.
- provides access to various service counters helping to reduce maintenance cost

Symbols are used instead of text throughout the whole menu structure.

STATUS	SECURITY LEVEL	DOCUMENT ID.	REV.	LANG.	PAGE
Approved	Public	2CDC112285M0201	E	en	5/57

1.2. Near Field Communication (NFC)

Every device of the smart monitoring relay family is equipped with an NFC antenna. This enables the parametrization of the devices with the ABB EPiC Mobile smartphone app via NFC.

To read or write data the smartphone needs to touch the surface of the CM-TCN. The connection is only active when the data transmission takes place. Contrary to e.g. Bluetooth there is no constant communication to the device. To learn more about NFC pairing and how to disable NFC communication, please refer to chapter 5.3. of this document.



NFC is an international transmission standard based on radio-frequency identification technology for the contactless exchange of data. This technology is already integrated in most electronic devices like tablets and smartphones and part of everyday life, e.g. for contactless payment.



The CM-TCN can be configured powered or without power supplied. This simplifies pre-configuration of devices for customers and helps optimize workflows.

ABB EPiC smartphone app

EPiC means “Electrification Products intuitive Configurator” and is the mobile application that allows to configure and check the status of the ABB low voltage products. The app is available for free and can be downloaded for Android and iOS. Registration with a user account is mandatory.

سازه گستر پایتخت

تامین کننده ملزومات برق

الکتریکال - مکانیکال - ابزار دقیق

۰۲۱-۶۶۱۷۲۰۳۲

www.sazehgostarsgp.com

@sazehgostar_paytakht

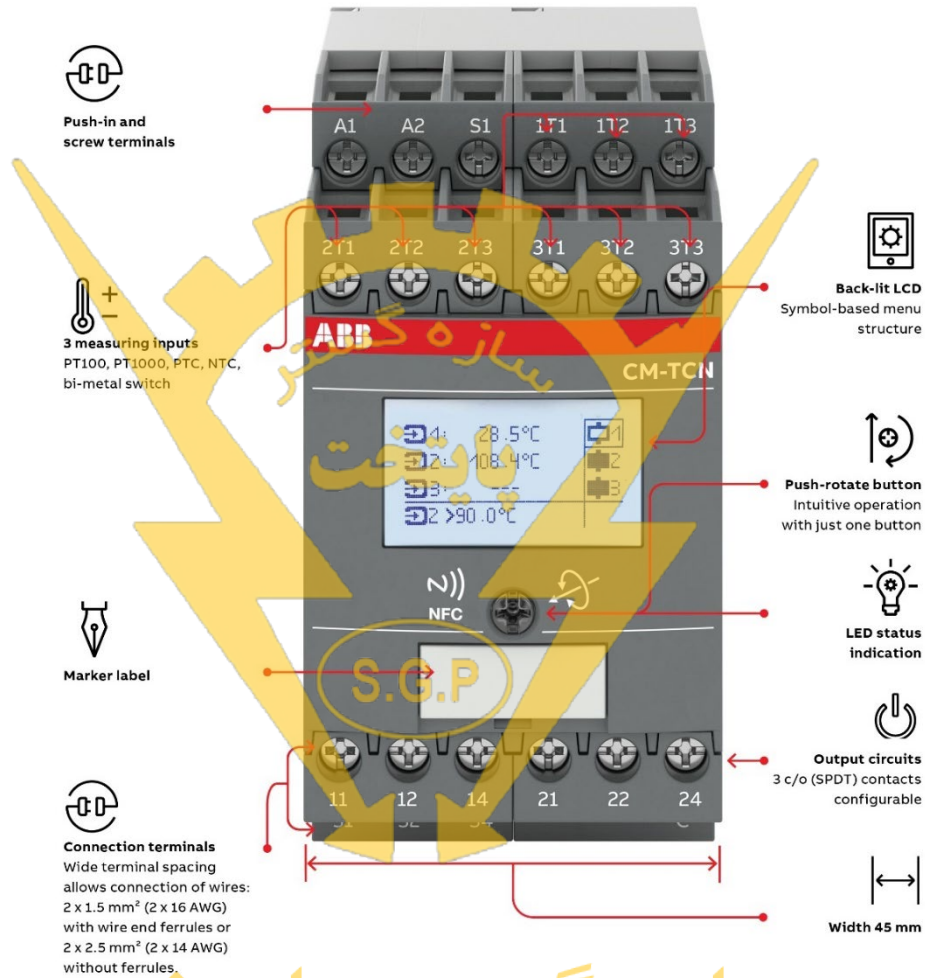

STATUS	SECURITY LEVEL	DOCUMENT ID.	REV.	LANG.	PAGE
Approved	Public	2CDC112285M0201	E	en	6/57

1.3. Device description

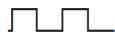
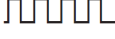
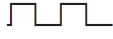
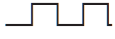
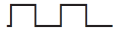

LED indication of operational states

Operational state	Description	Green	Orange	Red
Power supply missing	Device is not powered via terminals A1-A2	OFF	OFF	OFF
Control supply voltage applied	Device is powered, no failures detected		OFF	OFF
Internal fault	An internal fault has been detected. The device must be reset by turning the power off and on again.	OFF	OFF	
Short circuit	A short circuit of one or more sensors has occurred.	OFF	OFF	
Wire break	A wire break of one or more sensors has occurred.	OFF	OFF	

Operational state	Description	Green	Orange	Red
Overtemperature / Measurement value exceeds high limit	One or more sensors have detected a temperature exceeding the over-temperature threshold or measurement limit (+ 850 °C)	OFF	OFF	
Undertemperature / Measurement value exceeds low limit	One or more sensors have detected a temperature exceeding the under-temperature threshold or measurement limit (- 200 °C)	OFF	OFF	
Parameter error	Parameter was set outside of specification (may appear only if the device is configured via NFC or Modbus RTU)	OFF		
NFC pairing	Device is ready for writing/reading parameters via NFC	OFF		OFF
Cyclic switching function running	The switch-on period is active for the cycling function.	OFF		OFF

2. Installation

2.1. Mounting and de-mounting

Snap-on mounting onto a 35 mm standard mounting rail, without using any tool.

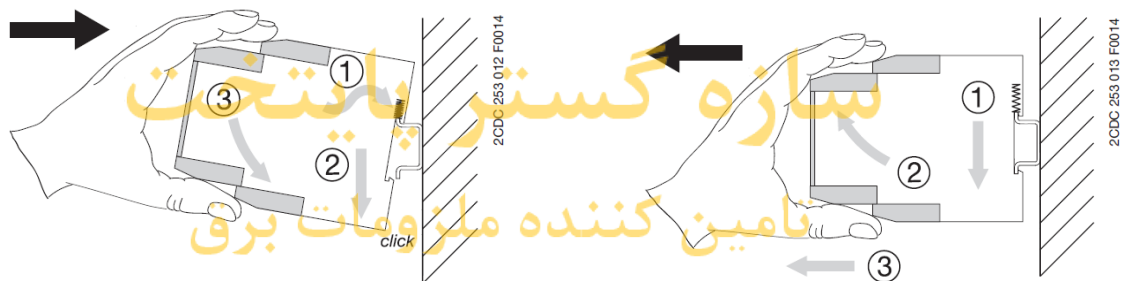

Mounting

De-mounting

2.2. Block diagram ۲۱-۶۶ ۱۷ ۲۰ ۳۲

The following block diagram shows the set-up of the CM-TCN.011 and CM-TCN.012: supply voltage range, connection of sensor types, control input, Modbus connection (only CM-TCN.012), function of output relays and the galvanic insulation.

 @sazehgostar_paytakht

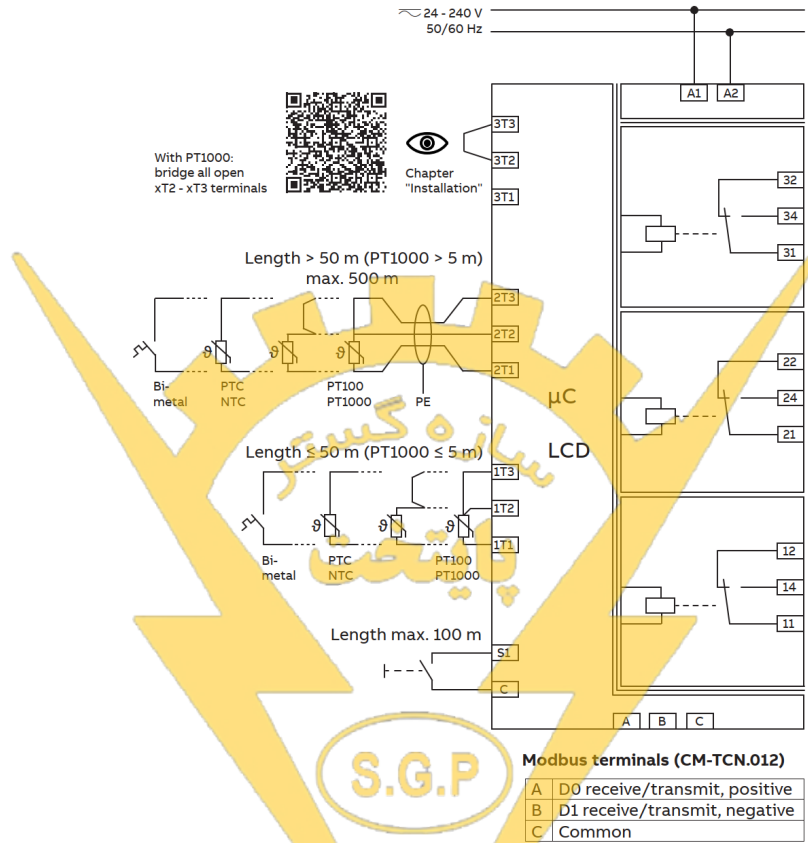

This block diagram is valid for CM-TCN.011 (product revision ≥ G) and CM-TCN.012. The block diagram for CM-TCN.011 (product revision ≤ F) can be found in the document 1SVC750040M0001.

2.3. Connection of resistance temperature detectors

2.3.1. 2-wire measurement

When using 2-wire temperature sensors, the sensor resistance and the wire resistance are added together. The resulting systematic errors must be considered when adjusting the tripping device. In addition, with two-wire connection a bridge must be inserted between terminals xT2 and xT3.

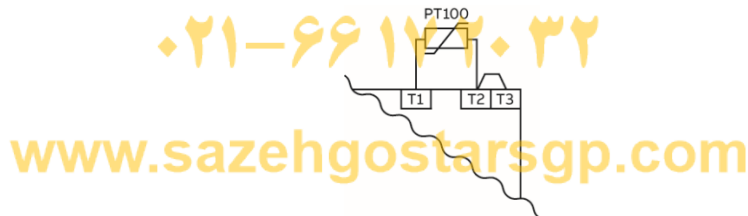

The error resulting from the line resistance of copper cable amounts to approx. 2.5 Kelvin/Ohm. If the resistance of the line is not known and it is not possible to measure it, the following table can be used to estimate the temperature error depending on the line length and conductor cross section. The table is valid for PT100 sensors at an ambient temperature of 20 °C, in K.

STATUS	SECURITY LEVEL	DOCUMENT ID.	REV.	LANG.	PAGE
Approved	Public	2CDC112285M0201	E	en	9/57

Line length in m	Wire size mm ²			
	0.50	0.75	1	1.5
10	1.8	1.2	0.9	0.6
25	4.5	3.0	2.3	1.5
50	9.0	6.0	4.5	3.0
75	13.6	9.0	6.8	4.5
100	18.1	12.1	9.0	6.0
200	36.3	24.2	18.1	12.1
500	91.6	60.8	45.5	30.2

2.3.2. 3-wire measurement

To minimize the influence of the wire resistance, a three-wire connection is usually used. By means of the additional wire, two measuring circuits are created. One of these two circuits is used for reference. This way, the tripping device can calculate and consider the wire resistance automatically.

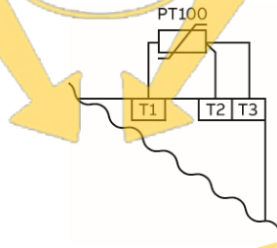

2.3.3. CM-TCN wiring when used with PT1000 sensor(s)

When CM-TCN is used with PT1000 sensors connected to the measuring circuit(s), a bridge must be installed between terminals xT2 and xT3 of unused measuring circuits.



A bridge must also be installed between open terminals xT2 and xT3 when CM-TCN is used with one or two PT1000 in combination with PTC or NTC or bimetal switch.

Possible connection options with PT1000 sensor(s) when xT2-xT3 bridge is required are shown below.

www.sazhegostarsgp.com

Example of bridged terminals with one or two PT1000 sensor(s):

@sazhegostar_paytakht

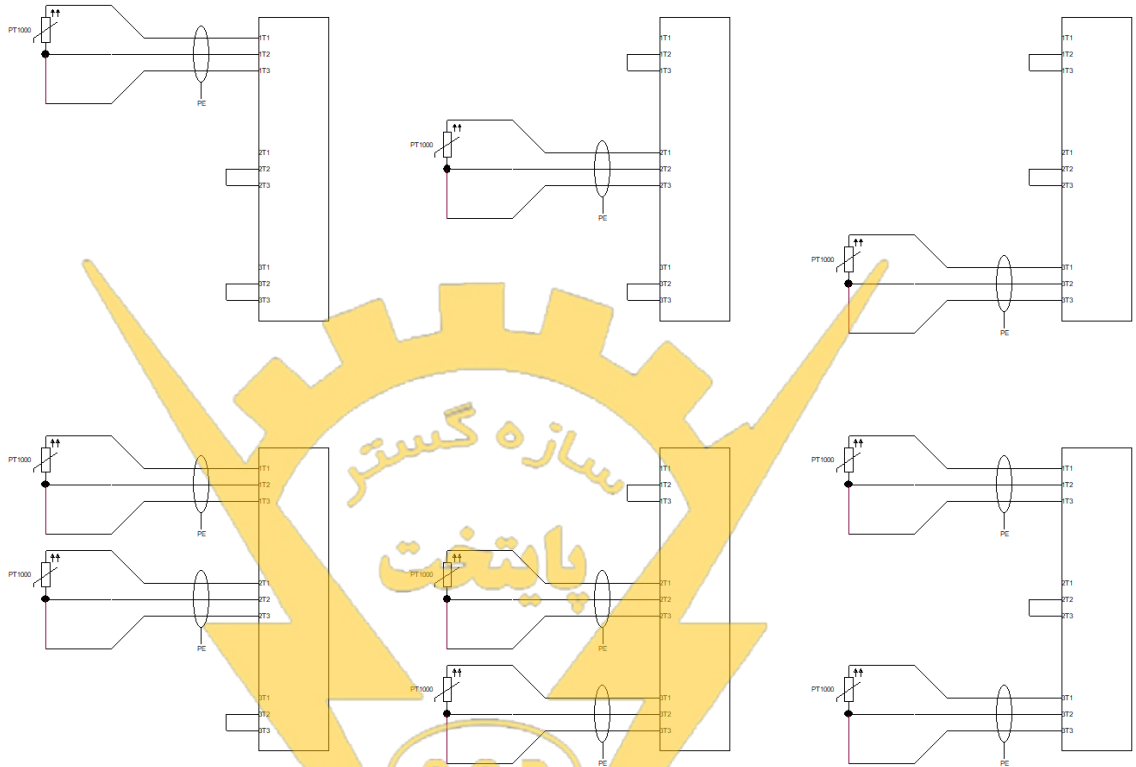

Example of bridged terminals with one PT1000 sensor and PTC or NTC or Bi-metal switch:

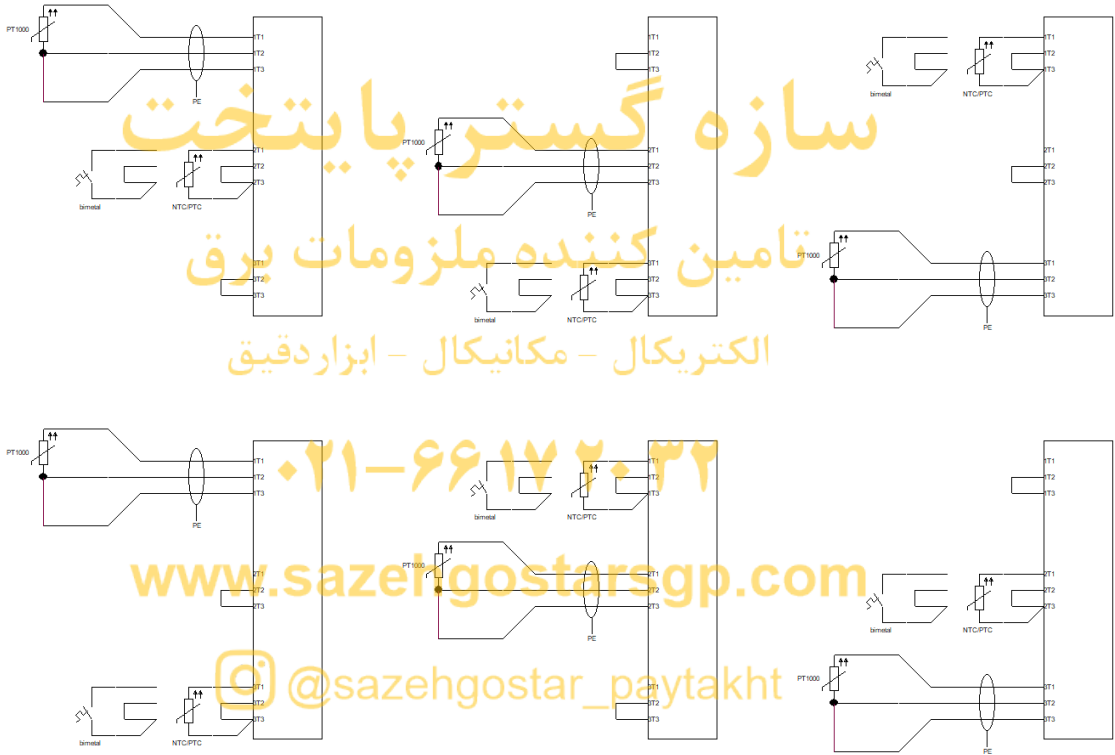

2.4. Sealable transparent cover

To protect the relay against unauthorized access and usage, a transparent sealable cover can be used. The cover is available as an accessory.

Before mounting the sealable cover, the standard marker label must be removed from the device and the mounting clip which is delivered together with the sealable cover must be snapped onto the device. After mounting the relay can be protected by a seal.

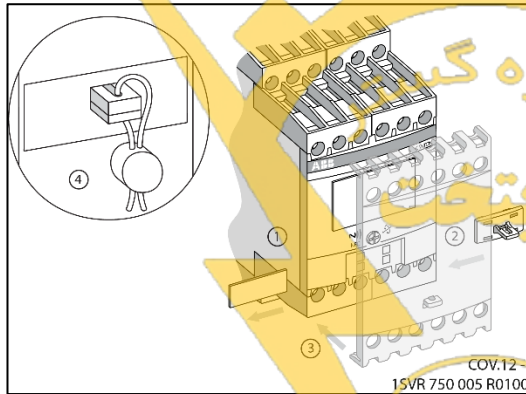

3. Commissioning

The smart temperature relays are configurable in three ways:

- The first option is via the LCD and the push-rotate button on the front of the device.
- The second option is to use the EPiC smartphone app.
- The third option is applicable only for CM-TCN.012. It can be commissioned using the Modbus RTU communication bus.

In the next sections the configuration via LCD and push-rotate button is explained.

3.1. Main screen

On the main screen the most important information is provided to oversee the status of the device. The main screen is divided in four sections, each containing a different set of information.



Section one displays the measured temperature in each measuring circuit (channel). Each channel is displayed by the symbol for channel  with a number

STATUS	SECURITY LEVEL	DOCUMENT ID.	REV.	LANG.	PAGE
Approved	Public	2CDC112285M0201	E	en	12/57

corresponding to the number of the measuring circuit e.g. channel 1 equals measuring circuit 1T1/1T2/1T3.

In **section two** the relay status is displayed. Through the symbol the actual status of the relay can be determined immediately: a white relay means the relay is deenergized and a filled-out symbol equals energized. The relays are numbered according to the numbers on the terminal e.g. relay 1 equals terminal assignment 11/12/14.

Section three is used in case of a relay trip to display the trip information per channel. This section also provides information regarding configurations which deviate from the default e.g. cyclic switching function running or simulation mode selected. In this case the symbol for e.g. cyclic switching function is shown here.

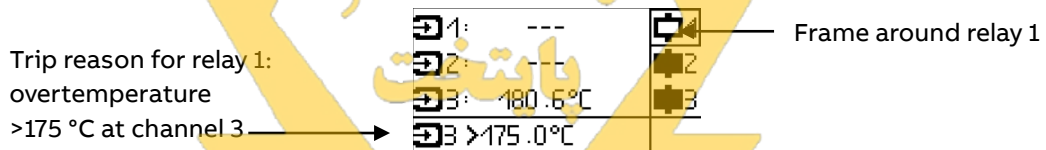

In case more than one trip is active, the information switches in a rhythm of 10 seconds between relays. The relay whose status is displayed will be framed. To view the trip reason for a specific relay the user can enter section two and rotate between the relays to display the needed value or to reset a trip in case manual reset is selected. With a rotate action section 2 will be entered. A frame will be displayed around the first relay and the trip reason for this relay will be displayed in the bottom line.

The device offers two reset options: automatic and manual reset. To reset the relays manually when manual reset is enabled press the push-rotate button when the frame is around one of the relay which could be reset.

The reset screen will open:



By clicking on a reset is conducted. To abort the reset and go back to the start screen select .



Default setting for all relays is automatic reset. In this case the reset menu will not be displayed. If manual reset is configured for a relay, the reset menu will become available automatically. The relays detect if the reset condition is reached. In case it is not reached the reset menu will not be available.

Example: In the picture displayed above, channel 1 shows a measured temperature of 180.6 °C. Navigating the frame to relay 1 shows that it has tripped because the

configured threshold for overtemperature monitoring at 175 °C at channel 3 has been reached.

Section 4 is only used for devices with Modbus (CM-TCN.012). The symbol in this section signals a started Modbus communication. The symbol \rightleftarrows indicates an active Modbus communication, while the symbol \leftarrow indicates a communication error.

3.2. Menu navigation

The operation of the device as well as the configuration is done via a push-rotate button which allows a precise menu navigation and accurate setting of any value.

The encoder can be operated either with a screwdriver or with the operating element OPR.01 which fits in into the screwdriver fitting.

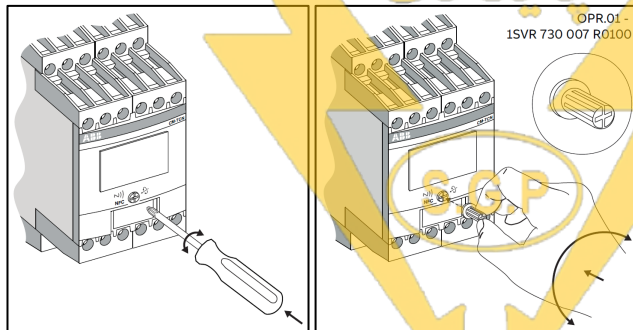

As soon as the relay is powered, the LCD lights up and the start screen shows the currently measured values. The menu is entered with a push on the push-rotate button. Through the rotation to the left or to the right the menu can be navigated. To enter a submenu the respective symbol must be selected. The values of the parameters can be selected through push-rotate actions. The set value becomes active immediately after leaving the menu. To exit a menu the back symbol can be used or pushing the push-rotate encoder for 2 s.



The display switches back to the main screen if no user interaction is detected within 30 s. The current setting remains unchanged.

www.sazhegostarsgp.com





@sazhegostar_paytakht

STATUS	SECURITY LEVEL	DOCUMENT ID.	REV.	LANG.	PAGE
Approved	Public	2CDC112285M0201	E	en	14/57

4. Configuration and setup

This section provides information how to configure the CM-TCN temperature relay with the help of profiles. There are two different profile categories – Factory and user profiles. The following sections explain each option and how to select and modify it.

The following parameters can be set:

Menu	Parameter	Symbol	Explanation	Data range
	Factory Profiles		One of seven profiles can be selected for immediate use or for optimized configuration	[yes, no]
	User profiles		The user can save individual parameter sets in one of four user profiles	[yes, no]
	Conducting a factory reset will delete the saved user profile configurations.			

4.1. Factory profiles

Factory profiles are parameter sets which offer default values for each parameter, covering the most common applications like e.g. motor or transformer monitoring and protection. These profiles allow a quick setup of the CM-TCN. Factory profiles are read-only and cannot be overwritten. Default is factory profile 1.

تامین کننده ملزومات برق









الکتريکال - مکانیکال - ابزار دقیق

۰۲۱-۶۶۱۷۲۰۳۲

www.sazhegostarsgp.com

 @sazhegostar_paytakht

The following factory profiles are available:

	Factory 1 	Factory 2 	Factory 3 	Factory 4 	Factory 5 	Factory 6 	Factory 7 
Settings 							
Channel 1	PT100	PT100	PT100	PTC	PT100	PTC	PT100
Channel 2	PT100	PT100	PT100	PTC	PT100	PTC	PT100
Channel 3	PT100	None	PT100	none	PT100	PTC	PT100
Relay assignment 							
Relay 1							
Working principle	NC	NC	NC	NC	NO	NO	NO
Signal	1,2,3	1,2	1,2,3	1	1,2,3	1	1
Threshold	Ch>130°C	Ch>90°C	Ch>150°C	PTC	Ch>130°C	PTC	Ch1>40°C
Hysteresis	10°C	5°C	10°C	-	10°C	-	2°C
Delay	0 s	0 s	0 s	-	OFF: 999.9s	OFF: 999.9s	0 s
Sensor error	-	-	-	-	-	-	1
Cyclic Switching	-	-	-	-	1	1	-
Period					1 week	1 week	
On-time					15 min	15 min	
Relay 2							
Working principle	NC	NC	NC	NC	NC	NC	NO
Signal	4,5,6	4,5	4,5,6	2	4,5,6	2	2
Threshold	Ch>150°C	Ch>110°C	Ch>170°C	PTC	Ch>140°C	PTC	Ch2>40°C
Hysteresis	5°C	5°C	5°C	-	5°C	-	2°C
Delay	0 s	0 s	0 s	0 s	0 s	0 s	0 s
Sensor error	-	-	-	-	1,2,3	1,2,3	2
Cyclic Switching	-	-	-	-	-	-	-
Relay 3							
Working principle	NC	NC	NC	NC	NO	NO	NO
Signal	-	-	-	-	7,8,9	3	3
Threshold					Ch>155°C	PTC	Ch3>40°C
Hysteresis					5°C	-	2°C
Delay					0 s	0 s	0 s
Sensor error	1,2,3	1,2	1,2,3	1,2	-	-	3
Cyclic Switching	-	-	-	-	-	-	-



Factory profile 1 is the default settings profile. The CM-TCN is delivered with the Factory profile 1 settings.

4.1.1. Factory 1: Motor protection with PT100 sensors

This profile allows motor supervision with two escalation steps. The first threshold is configured as a pre-warning at 130 °C for all measuring circuits. When the threshold is reached, relay 1 will trip (deenergize). The second threshold controls the switch off at a temperature of 150 °C. Relay 2 will trip if the threshold value is measured by any of the three measuring circuits. In case of sensor errors in any of the three sensor circuits (short circuit, open wire) relay 3 is triggered immediately.

The relays energize again when the measured temperature falls below the threshold plus the set hysteresis value. The hysteresis is set to 10 °C for the pre-warning and 5 °C for the switch off threshold.

The relays operate in closed-circuit principle. Automatic reset is active for all output relays.

The operating logic and the settings are displayed in the block diagram:

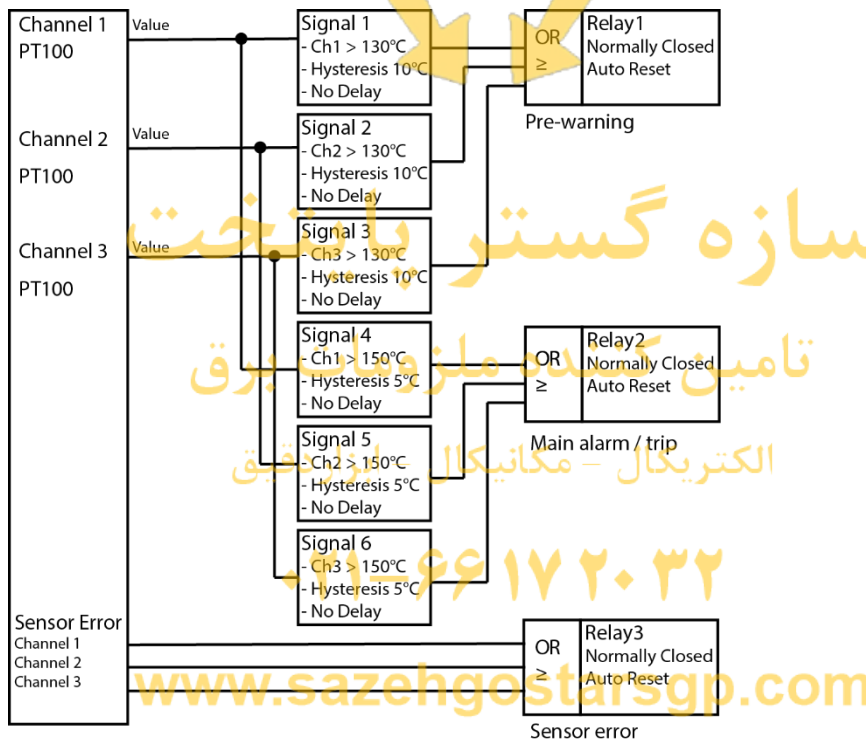

@sazehgostar_paytakht

STATUS	SECURITY LEVEL	DOCUMENT ID.	REV.	LANG.	PAGE
Approved	Public	2CDC112285M0201	E	en	17/57

4.1.2. Factory 2: Motor bearing supervision with PT100

Profile 2 focuses on motor bearing instead of motor winding supervision. For each of the bearings (left and right) a PT100 sensor is configured. Like the motor winding supervision, the profile offers a pre-warning at 90 °C tripping relay 1 and a switch off threshold at 110°C tripping relay 2.

The hysteresis for both thresholds is set to 5 °C.

Relay 3 trips in case of sensor errors. The relays operate in closed-circuit principle. Automatic reset is active for all output relays.

The operating logic and the settings are displayed in the block diagram:

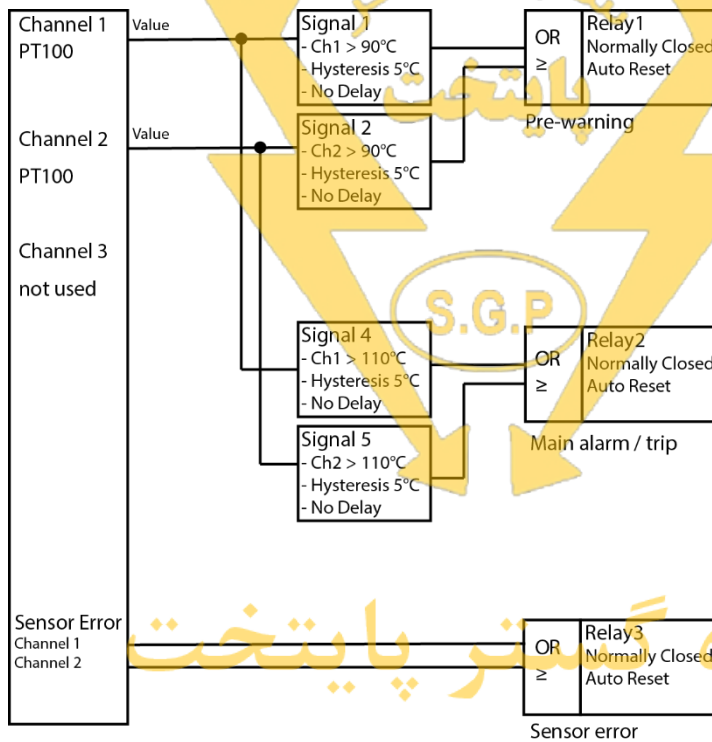

تامین کننده ملزومات برق

الکتريکال - مکانیکال - ابزار دقیق

۰۲۱-۶۶۱۷۲۰۳۲

www.sazehgostarsgp.com

@sazehgostar_paytakht

4.1.3. Factory 3: Motor supervision with PT100 – 2

Profile 3 follows the same logic as profile 1. The temperature thresholds are configured for higher temperatures. Threshold number 1 trips at 150 °C and threshold number 2 is reached at 170 °C.

The relays operate in closed-circuit principle. Automatic reset is active for all output relays.

The operating logic and the settings are displayed in the block diagram:

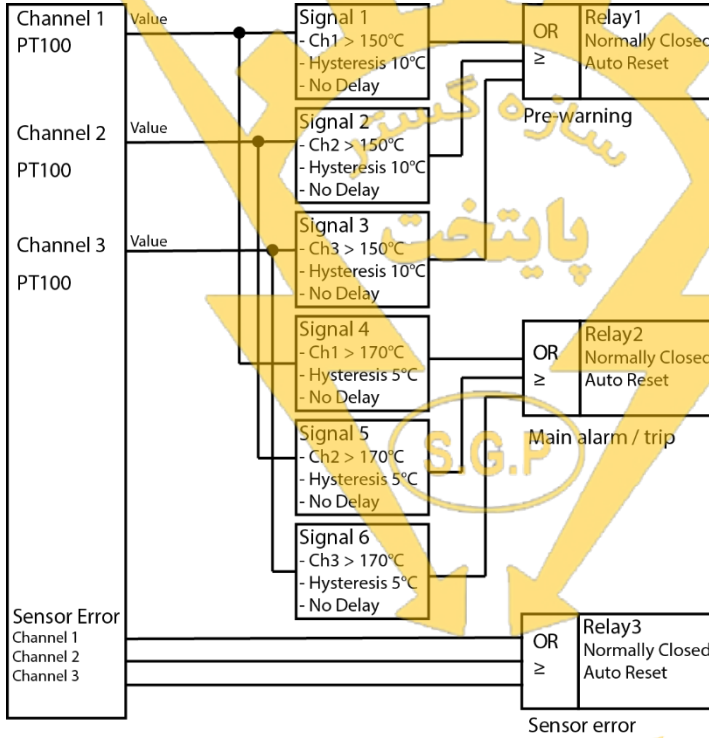

سازه گستر پایتخت

تامین کننده ملزومات برق

الکتریکال - مکانیکال - ابزار دقیق

۰۲۱-۶۶۱۷۲۰۳۲

www.sazehgostarsgp.com

@sazehgostar_paytakht

4.1.4. Factory 4: Motor winding supervision with PTC

This profile allows motor supervision with two escalation steps. The threshold correlates to the used PTC sensors. If the first threshold is reached, relay 1 will trip and for the second threshold relay 2. In this profile channel 1 correlates to signal 1 and channel 2 to signal 2.

Relay 3 trips in case of sensor error at one of the measuring circuit.

The relays operate in closed-circuit principle. Automatic reset is active for all output relays.



The maximum permitted cold state resistance in series is 750 Ohm.



In the signal menu the settings for threshold and hysteresis are disabled for the corresponding signals if PTC is set as sensor.



For conformity with IEC 60947-8 the equipment needs to be switched-off in case of sensor error. This is to be taken into consideration during the wiring or in the device configuration.

The operating logic and the settings are displayed in the block diagram:

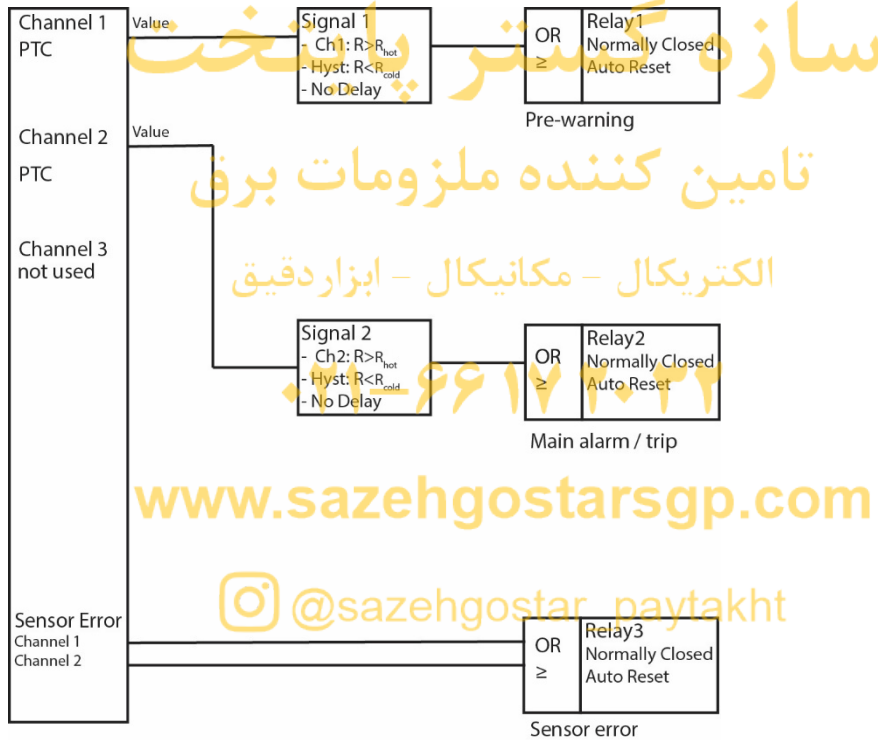

4.1.5. Factory 5: Transformer supervision with PT100

This profile allows transformer supervision with three escalation steps. Threshold 1 is set to 130 °C and starts ventilation for cooling. If the threshold is reached relay 1 trips. Additionally, a cyclic switching function is assigned to relay 1 to periodically switch the relay once per week for 15 minutes to keep the fan from clogging.

Threshold 2 is a pre-warning at 140 °C and trips relay 2. Additionally, to the threshold configuration the sensor error signals are assigned to relay 2.

Threshold 3 is for the switch off at 155 °C.

Relays 1 and 3 operate in open-circuit principle, relay 2 in closed-circuit principle. Automatic reset is active for all relays.

The operating logic and the settings are displayed in the block diagram:

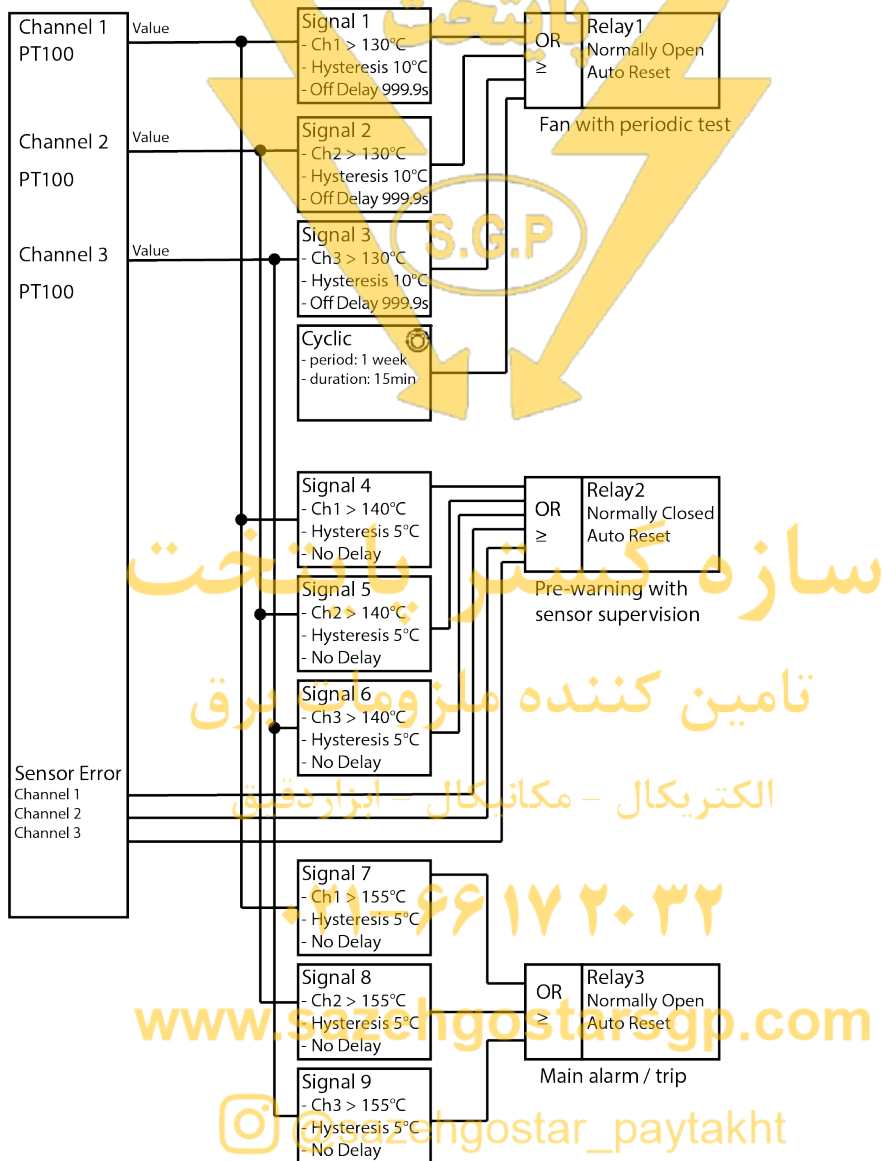

4.1.6. Factory 6: Transformer supervision with PTC

Profile 6 follows the same logic as profile 5 with PTC sensors. In this setting each measuring input correlates to one output relay: channel 1 to relay 1, channel 2 to relay 2 and channel 3 to relay 3. The temperature thresholds depend on the selected PTC sensors.

Cyclic switching function 1 is assigned to relay 2.

Relay 2 trips in case of sensor error for all measuring circuits.

Relay 1 and 3 operate in open-circuit principle, relay 2 in closed-circuit principle. Automatic reset is active for all output relays.

The operating logic and the settings are displayed in the block diagram for detailed information:

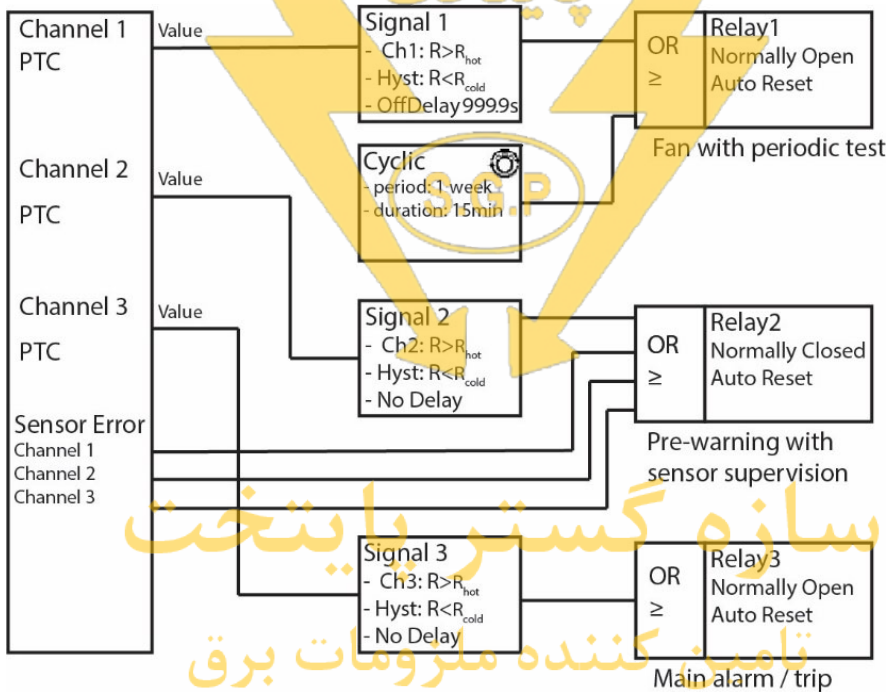

الکتریکال - مکانیکال - ابزار دقیق

۰۲۱-۶۶۱۷۲۰۳۲

www.sazhegostarsgp.com

@sazhegostar_paytakht

4.1.7. Factory 7: Individual temperature supervision with PT100

In this profile each channel corresponds to one of the relays: channel 1 to relay 1, channel 2 to relay 2 and channel 3 to relay 3.

The sensor error is assigned for each channel to the corresponding relay. All thresholds are set to measure overtemperature at 40 °C. The relays work in the open-circuit principle. Automatic reset is active for all relays.

The operating logic and the settings are displayed in the block diagram for detailed information:

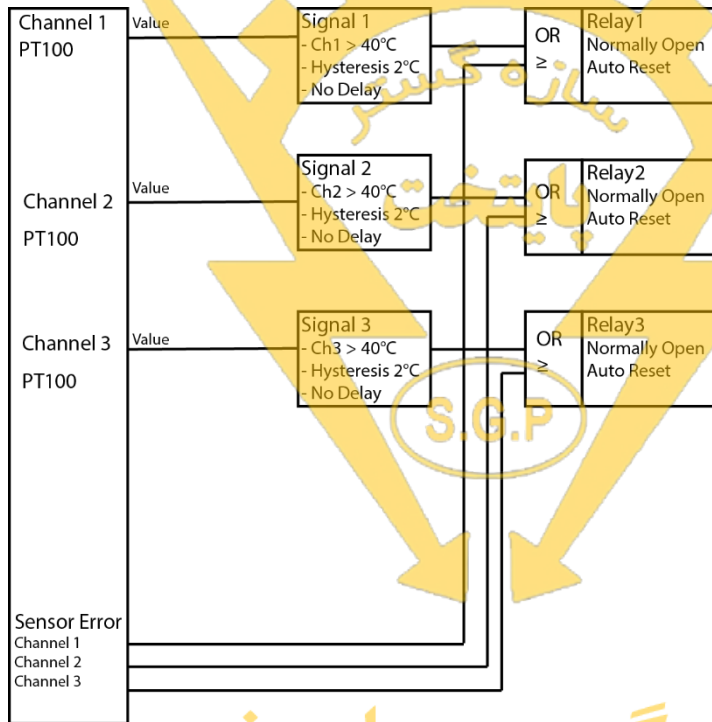

سازه گستر پایتخت

تامین کننده ملزومات برق

الکتریکال - مکانیکال - ابزار دقیق

۰۲۱-۶۶۱۷۲۰۳۲

www.sazehgostarsgp.com

@sazehgostar_paytakht

STATUS	SECURITY LEVEL	DOCUMENT ID.	REV.	LANG.	PAGE
Approved	Public	2CDC112285M0201	E	en	23/57

4.2. User profiles and individual parameterization

All parameters within the CM-TCN can be adjusted according to the users' needs. The individual parametrization consists of three steps: sensor configuration, signal definition and relay assignment.

- **Step 1:** First, configure the connected sensor type for each measuring circuit (channel 1 – 3). It is possible to configure each input individually e.g. channel 1 as PT100, channel 2 as PT1000 and channel 3 as PTC input.
- **Step 2:** Define the signals which compare the measured temperature from one of the three channels with the configured threshold. The following operators are available: < >
Additionally, temperature differences between two measuring circuits can be monitored and set as threshold. The absolute difference is measured. The configured sensors must be the same for both channels. This function is only possible with PT100, PT1000 and NTC sensor configuration.
- **Step 3:** Allocate the signals to a relay output. This means that as soon as a signal becomes true the assigned relay output is activated. It is possible to allocate multiple signals to the same relay output. In this case the relay output becomes active as soon as at least one signal is true (or operation).



It is most convenient to select a profile with settings similar to the needed ones and modify just the parameters which differ from the required configuration.

4.2.1. Step 1: Sensor configuration



In this menu the general settings for the measuring circuits can be made. Select here which sensor type is connected to which input.

The picture below shows the screen for the setting menu:

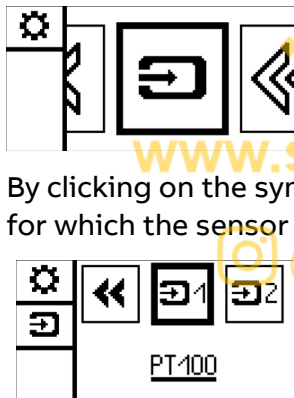





By clicking on the symbol, the sub menu is entered. In the sub menu the channel, for which the sensor should be set, can be selected:



Currently channel 1 is selected and the configured sensor is PT100. By pushing the symbol for channel 1 the sub menu is entered. Pushing again will enable to change the sensor type by rotation. To confirm the selection, another push action is needed. The sub-menu is left automatically after confirmation.

The following parameters can be set:

Menu	Parameter	Symbol	Explanation	Data range
Settings 	Measuring circuit 1		Selection of the sensor type for measuring circuit 1 – 1T1, 1T2, 1T3	[none], [PT100], [PT1000], [PTC], [NTC], [Bi-metal switch] Default: PT100
	Measuring circuit 2		Selection of the sensor type for measuring circuit 2 – 2T1, 2T2, 2T3	[none], [PT100], [PT1000], [PTC], [NTC], [Bi-metal switch] Default: PT100
	Measuring circuit 3		Selection of the sensor type for measuring circuit 3 – 3T1, 3T2, 3T3	[none], [PT100], [PT1000], [PTC], [NTC], [Bi-metal switch] Default: PT100

4.2.2. Step 2: Signal definition



In this menu up to nine different signals and three cyclic switching functions can be configured. A signal setting consists of the threshold configuration, the hysteresis and ON- and OFF-delay settings related to the threshold.

With a cyclic switching function regular switching of equipment according to a defined time schedule can be realized, e.g. weekly switching of a fan for 15 minutes to reduce risk of clogging due to non-movement. More information can be found in chapter relay assignment.

For configuration select signal S1-S9 or cyclic switching function CF1-CF3 by rotating through the menu and push the selected one.

Signals – Signal 1:  @sazehgostar_paytakht

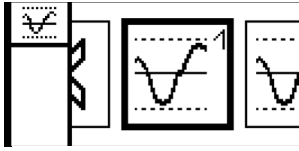

After selecting a signal, the first screen displays the threshold configuration. By clicking on the symbol, the sub menu for threshold configuration in the bottom line is entered and the values can be adjusted.

Signal 1 – Threshold:



By rotating the push-rotate button left or right other sub menus can be selected: hysteresis, ON-delay and OFF delay configuration. Pressing the back symbol in the sub menu leads back to the higher level.

The following values can be set for signals 1-9:

Menu	Parameter	Symbol	Explanation	Data range
Signals 1-9	Signal source		These parameters configure the thresholds e.g. channel 1 (symbol channel) > 175°C	[Ch1], [Ch2], [Ch3], [DiffCh1Ch2], [DiffCh1Ch3], [DiffCh2Ch3]
	Over- or undertemperature			[<], [>]
	Temperature value			[-200...+850 °C] [-328...+1562 °F]
	Hysteresis		Configuration of hysteresis related to threshold	Default: Factory 1 [1...99.9 °C] [1.8...179.8 °F]
	ON-delay		Configuration of ON-delay: delayed switching of the relay after the threshold is reached	Default: Factory 1 [0 – 6553.5 s] Default: 0 s
	OFF delay		Configuration of OFF-delay: delayed switching of the relay after the threshold plus hysteresis value is reached	[0 – 6553.5 s] Default: 0 s

@sazehgostar_paytakht



The setting options for the signals depend on the sensor selection in the device settings. In case PTC or bi-metal is configured for the selected channel, the options to define threshold and hysteresis or delays, will automatically be removed from the signal.

In case of incompatibility between sensor type and signal configuration, an exclamation mark will be displayed next to the incompatible setting. This can happen when the sensor type has been changed, but the previous signal settings are not compatible with the new sensor type. To remove the exclamation mark, click on the incompatible value and perform a rotate action.

Threshold



Entering the threshold menu allows setting of the signal source, over- or under-temperature monitoring and the temperature value. Signal source refers to the sensor circuit from which the measured temperature values is taken as reference to the configured threshold. The CM-TCN provides three independent sensor circuits: 1T1/1T2/1T3, 2T1/2T2/2T3 and 3T1/3T2/3T3

Signals 1 – Threshold:



The currently selected parameter is underlined, signaling it can be changed by rotating. After adjusting the new value, another push action confirms the new selection or exits the configuration.

Threshold – Channel selection:



Clicking on  leads back to the next higher menu stage. Alternatively, the button can be pressed for 2 seconds.

Hysteresis



www.sazehgostarsgp.com
 @sazehgostar_paytakht

In this sub menu the hysteresis related to the configured threshold can be set. The term hysteresis refers to the release of an energized relay after its threshold value has been reached again.

Example: The relay picks up if the temperature rises above 100 °C, i.e. over-temperature detected, output relay is energized (open-circuit principle), but it does not de-energize immediately if the temperature decreases to the threshold value of 100 °C again but only after the threshold minus hysteresis value has been reached e.g. 95 °C.

The hysteresis is given as an absolute value added or subtracted to the threshold value depending on if the configuration is under- or overtemperature monitoring. The release hysteresis prevents the relay from toggling on and off in case of temperature variations around the threshold value.

Hysteresis menu:



ON and OFF Delay

With the ON and OFF delay settings a time delayed switching of the output relay can be realized. The ON-delay allows a delayed switching of the relay according to the configured time when the threshold value is reached. The OFF-delay keeps the relay from switching back for the set amount of time after the measured value has reached the threshold plus hysteresis value.

ON-delay menu:



Cyclic switching function



The cyclic switching function follows a periodical rhythm. The user can define the cycle time and the on-time. The cycle time is the period after which the ON-time is scheduled e.g. one week. The ON-time is the time for which the relay switches positions e.g. 20 minutes. This function can be used to keep e.g. fans from clogging.

Cyclic-switching-function menu:

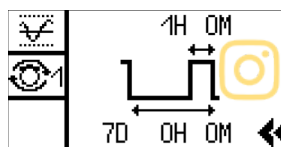

In the example settings the cycle time is set to seven days and the ON-time to one hour, which means that the relay is tripped every week for one hour.

4.2.3. Step 3: Relay assignment and configuration





In this step the signals defined in the previous step can be allocated to an output relay. It is possible to allocate one or more signals to an output relay. Additionally, sensor error signals can be assigned. The CM-TCN.012 monitoring relay also allows to assign bus signals 1-3 and bus fault to an output relay. These signals are available per default and cannot be changed by the user.

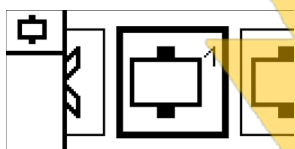

Beside the signal allocation the working principle and the reset option are configured in this step as well. When entering the menu, first select the relay to configure. The number in the top right corner refers to one of the three relays. Relay 1 corresponds to terminals 11-12-14, relay 2 to 21-22-24 and relay 3 to 31-32-34.

Relay menu with relay 1 selected:



By clicking on the relay, the sub menu of the selected relay is entered. The following parameters can be set for each relay:

Menu	Parameter	Symbol	Explanation	Data range
Relay 1-3 	Signals		The signals defined in the previous menu can be assigned to one of the three relays.	[1, 2, 3, 4, 5, 6, 7, 8, 9] Default: Factory 1
	Cyclic switching function		One of the three cyclic switching functions defined in the previous menu can be assigned one of the three relays.	[1, 2, 3] Default: none
	Sensor Error		A sensor error signal can be assigned to one of the relays. For every measuring circuit one sensor error signal is available. Channel 1 corresponds to Sensor Error 1.	[1, 2, 3] Default: Factory 1
	Working principle		The relay working principle can be adjusted independently for each of the three relays.	[NO, NC] Default: NC

Reset		For each relay an automatic or manual reset can be set.	[Auto, Manual] Default: Auto
Bus signal (only CM-TCN.012)		Direct control of output relays using the communication bus.	[1, 2, 3] Default: none
Bus fault (only CM-TCN.012)		Assignment of the bus fault reaction in case of Modbus timeout.	[enable, disable] Default: disable

Signal assignment

In this step the configured signals can be assigned to the previously selected relay. Using the push-rotate button allows to select the available signal categories one by one: Threshold, cyclic switching function, sensor error, bus signal and bus fault. Additionally, the working principle and the reset option can be defined.

The following picture displays the assignment menu for threshold settings. The numbers represent the signals one to nine configured before. By rotating the push-rotate button each of the numbers can be selected. To assign a signal the button needs to be pressed. The black background behind the number means that this signal is assigned to the relay.

Relay 1 – threshold signal:



In the picture signal 1 is currently assigned to relay 1. The cursor on signal 2 signals the user the position on the display. For the signal on which the cursor is currently positioned, the configuration is shown in the bottom line of the screen. In the picture for signal 2 the threshold configuration is CH2 > 175.0 °C

Cyclic switching function



The assignment of the cyclic switching functions follows the same principle as the assignment of the threshold signals.

Sensor error signals



The assignment of the sensor errors follows the same principle as the assignment of the threshold signals.

Relay 1 – Sensor error:



Contrary to the previous signals the sensor errors are default signals. They are set in case of a sensor fault. The measurement circuits detect short circuit or wire break at their inputs. These sensor errors can be assigned to any relay. No additional configuration is required.

Bus signal (only CM-TCN.012)



The output relays can be controlled directly using the Modbus communication bus. There are three registers available in the Modbus register map, which can be assigned to any relay.

Modbus Address	Parameter	Type	Value/unit	Read/Write	Min	Max	Default
0x0000	Bus signal 1	Bit	0: Off 1: On	R/W	0	1	0
0x0001	Bus signal 2	Bit	0: Off 1: On	R/W	0	1	0
0x0002	Bus signal 3	Bit	0: Off 1: On	R/W	0	1	0

Relay 1 – Bus signal:

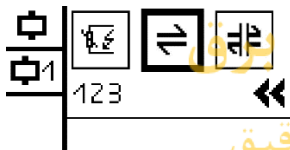

The numbers represent the bus signals one to three. By rotating the push-rotate button each of the numbers can be selected. To assign a bus signal the button needs to be pressed.

Bus fault reaction (only CM-TCN.012)



@sazehgostar_paytakht

The user can define the behavior of the output relays in case of Modbus timeout. Two options are available for each relay:

STATUS	SECURITY LEVEL	DOCUMENT ID.	REV.	LANG.	PAGE
Approved	Public	2CDC112285M0201	E	en	31/57

- Enable bus fault – the relay will be energized (NO) / deenergized (NC) in case of Modbus timeout
- Disable bus fault – no reaction of the relay to a communication error

Relay 1 – Bus fault:



Relay working principle



For each of the relays the working principle can be adjusted to open-circuit principle (NO) or closed-circuit principle (NC). The default setting is closed-circuit principle (NC) for profile 1. Closed-circuit principle means that in case of no event the relay coil is energized immediately. If an error occurs the relay de-energizes. Whereas open-circuit principle means that in case of no even the relay coil is de-energized and if an error occurs the relay energizes.

Relay 1 – working principle:

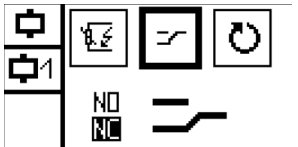

Reset / trip acknowledge



The CM-TCN devices offer two reset options: manual or automatic reset. The default setting for all relays is automatic reset.

When the configuration is automatic reset, the relay will switch back to its default position as soon as the measured temperature is below or above (depending if over- or undertemperature monitoring is set) threshold value plus hysteresis value and no other switching condition is active.

With the manual reset the relay will remain in the switched position even if the good state is reached again. The user needs to manually activate the reset either via the display or remotely via terminals S1-C.

Relay 1 – Reset:



4.2.4. Save configuration into user profiles



User defined profiles offer the opportunity to save a user-specific configuration on the device for later reuse. In total there are four user defined storage spaces. To save a new setting the saving icon in the main menu needs to be selected:



Four user defined profiles will show up, displayed by the person icon. The number in the top right corner represents the number of the user profile. Any profile can be selected to save the data.

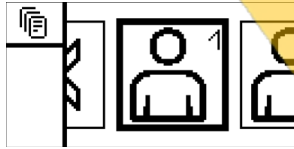

After the selection the device will ask for confirmation of the selection:



Selecting the cross will abort the saving process. Confirmation via tick will save the configuration to the selected user profile. After saving a user profile, it can be selected from among four user profiles in the "Profiles" menu. The selected user profile will be marked with a check mark.

الکتریکال - مکانیکال - ابزار دقیق

۰۲۱-۶۶۱۷۲۰۳۲





www.sazehgostarsgp.com

@sazehgostar_paytakht

STATUS	SECURITY LEVEL	DOCUMENT ID.	REV.	LANG.	PAGE
Approved	Public	2CDC112285M0201	E	en	33/57

5. Security

The CM-TCN offers different security options to protect the information and settings from unauthorized access and changes. The parameter lock and the password protection can be set in the security menu accessible via the main menu. Additionally, the device offers the opportunity to disable NFC.

Menu	Parameter	Symbol	Explanation	Data range
	Parameter lock		This mode prevents change of any parameters at the display menu. It can be enabled/ disabled at any time.	[enable, disable] Default: disable
	Password protection		A four-digit password can be set for the device	[enable, disable] Default: disable
	NFC		NFC can be set to enabled or disabled	[enable, disable] Default: enable

5.1. Parameter lock



The parameter lock is an additional function to protect the device from accidental changes. Contrary to the password protection every user who has access to the device can enable or disable the parameter lock.

The parameter lock can be activated in the security menu. From the moment the parameter lock is activated no further settings can be made. All menus can still be accessed in a read-only mode. When trying to change settings while the parameter lock is enabled the symbol for parameter lock will be shown on the display to remind the user that the mode is still enabled:



5.2. Password protection



A user-selected four-digit password can be set for the device. To enable the password, select the symbol for password enabled in the security menu. The user will be asked to provide an individual four-digit password. After the password selection, the password protection becomes active.

Security – password protection enabled:



As soon as the password is active, no parameters can be changed without first having entered the password.

A request to enter the password is made every time the user wants to access the configuration menu. Instead of entering the password and thus enabling full parameter setting functionality the user can select the read-only mode. The read-only mode works like the parameter lock and gives the operator full read access to the menus to e.g., check data and values but does not allow parameters to be changed.

Security – read only mode:



Security – enter password:



The device will show the symbol for password protection in case the user tries to enter the parameter configuration while in read-only mode:



5.3. Near Field Communication



For the CM-TCN device, NFC communication can be disabled either via the display menu on the device itself or through the app.



When NFC is disabled, no further communication with the EPiC Mobile app is possible. To enable the communication again, NFC needs to be enabled directly at the device.

NFC pairing

If the device is powered the button needs to be pressed for three seconds to enable NFC communication to EPiC app while on the main screen. This enables NFC-pairing for 15 seconds, during which time a connection must be established. During the 15 seconds time frame the LED is blinking orange.

This ensures that NFC communication can only be established by an authorized person, which has access to the device and pushes the button.

If the device is unpowered NFC communication is always enabled unless selected otherwise.

Security – NFC disabled:



سازه گستر پایتخت

تامین کننده ملزومات برق

الکتریکال – مکانیکال – ابزار دقیق

۰۲۱-۶۶۱۷۲۰۳۲







www.sazehgostarsgp.com

@sazehgostar_paytakht

STATUS	SECURITY LEVEL	DOCUMENT ID.	REV.	LANG.	PAGE
Approved	Public	2CDC112285M0201	E	en	36/57

6. Additional functions

In additional functions device-related settings like temperature unit can be found. Additionally, the menu offers the user the possibility to store up to three individual texts in the device.

Menu	Parameter	Symbol	Explanation	Data range
Common settings	Display ON-time		Time during which the display backlight is on.	[OFF, 10 s, 30 s, 1 min, 2 min, 5 min, 10 min, 30 min, 1 h, ON] Default: 30 s
Device:				
	Temperature unit		Selection of the temperature unit in which temperature values will be displayed and processed	[Celsius °C, Fahrenheit °F] Default: °C
App:				
	Power-on delay		Delay after relay start-up. During this phase the relay does not evaluate the measured values.	[3.0-999.9 s] Default: 3 s
	User defined text 1-3		A user defined text consisting of eight digits can be stored	[A-Z, 1-9, :, ;, ,, ,, -, <, =, >, ?, /, °] Default: -----

6.1. Display ON-time



The display ON-time means the time the display back light will stay on after no action is registered. The backlight can be continuously on or off or be set to a specific time. **تامین کننده ملزومات برق الکتریکی - مکانیکال - ابزار دقیق**

The default display ON-time is 30 seconds.

Common settings – display ON-time: **۰۳۲ ۰۲۰ ۰۱۷ ۰۱۶ ۰۱۱**



www.sazhegostarsgp.com

 @sazhegostar_paytakht

6.2. Temperature unit



The temperature unit can be individually set to either Celsius °C or Fahrenheit °F. By changing the temperature unit all parameters in the device are automatically adapted to the new unit, no further adjustments from the user-side are needed.

Common settings – Temperature unit:



6.3. Power-on delay



The device has a configurable power-on delay. During the power-on phase the measured values are not evaluated by the relay and therefore do not lead to a premature trip. In addition, no configuration changes become active. Modbus communication (only CM-TCN.012) is disabled while power on delay is running.

The default start-up time is 3 seconds.

Common settings – Power-on delay:



6.4. User-defined text



The device offers the option to save up to three user-defined texts with up to 8 signs. They can be used for device specific information like location, use etc. ASCII signs only.







Common settings – user-defined text:





7. Condition monitoring

In the condition monitoring menu, the user finds additional information events, average measured temperatures, operating counter, and the simulation mode.

The following values can be set for each parameter:

Menu	Parameter	Symbol	Explanation	Data range
	Event history		The events contain all information related to a relay trip. Up to 10 events are stored.	[No settings possible] Can be reset by the user
	Operating hour counter		The operating hour counter stores lifetime information about the relay.	[No settings possible] Cannot be reset by the user
	Maintenance counter		The maintenance counter counts the trips per relay.	[No settings possible] Can be reset by the user
	Statistics		In statistics the user finds the minimum, maximum and average measured temperature values per measuring circuit.	[No settings possible] Can be reset by the user
	Password reset counter		Numbers of password resets is counted.	[No settings possible] Cannot be reset by the user
	Simulation mode		Simulation mode for simulation of temperature values and relay trips.	Channel 1-3: [-200 ... +850 °C] Relay 1-3: [NO, NC]
	www.sazehgostar-sgp.com			

 @sazehgostar_paytakht

Scan 2D code		Scanning the barcode with a smartphone leads to the official ABB website where more information and documentation related to the product can be found	[No settings possible]
Factory reset		A factory reset for the device can be conducted.	[yes, no]
Device information		Device information about Firmware version, Order code and more are stored here.	[no settings possible]

7.1. Event history



In the event history all events are listed. These include all relay trips, error conditions and cyclic switching function events. The information displayed for each event consists of the tripped relay, information related to the cause of the event (threshold reached, cyclic switching function, error condition) and the time when the event happened measured in time since power-on.

One event is displayed at a time. To see all events, scroll through the event history. It is possible to delete the whole event history. Pressing the button will lead to the delete and back option. A maximum of ten events is stored in the event history. In case the buffer is full, the oldest event will be deleted in favor of a new one. The event history remains stored even after a new power cycle is started. The date code of the event that occurred before the last power cycle will be cleared to inform the user.

Example 1 - overtemperature:

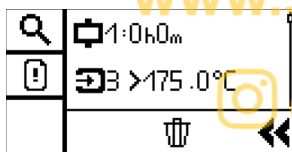

Example 2 – sensor short circuit:



7.2. Operating hours counter



The operating hours counter provides information about the total on-time of the device, the time since the last power-on and the total energized time of each output relay. To see all information, scroll through the list. Pushing the push-rotate button will lead back to the condition monitoring menu.

Condition monitoring – operating hour counter:



The values cannot be reset.

7.3. Maintenance counter



In this menu the trips for lifetime are counted as well as actual number of trips since last reset are counted. The actual relay trip counter can be reset. To reset press the push-rotate button and select .

The device will ask for confirmation:



With the confirmation all actual trip values are reset.

Condition monitoring – maintenance counter:

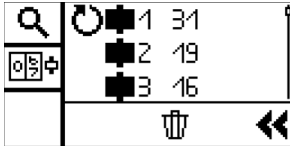

7.4. Statistics



The statistics menu provides information about the lowest measured temperature, the highest measured temperature, and the average measured temperature for each measuring circuit. The values can be reset.

Condition monitoring – statistics:



7.5. Password reset counter



The password reset counter counts how often the password has been reset by the user and displays the time when the password was reset the last time. The time given as a value related to the time since power on.

Condition monitoring – password reset counter:

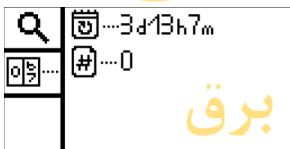

7.6. Simulation mode



The simulation mode can be used for commissioning or testing. There are two options in the simulation mode: Simulation of temperature values to test the relay configuration or simulation of trip of the relays.

The flashing symbol for simulation mode is displayed in the bottom pane of the display. The user can navigate through the simulation mode by rotating. To change a value or a relay position, the according symbol needs to be clicked. For the channels the temperature can be simulated by clicking and rotating. The changes are effective immediately. The user can use this mode to test the

STATUS	SECURITY LEVEL	DOCUMENT ID.	REV.	LANG.	PAGE
Approved	Public	2CDC112285M0201	E	en	42/57

settings and check the relay behavior in case of temperature changes. The relays can also be reached via rotation. Clicking on a relay changes its state immediately.

Condition monitoring – simulation mode:

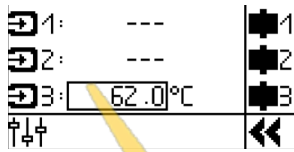

The simulation mode will stay active for 15 minutes if no user interaction is detected. The symbol for simulation mode will be displayed on the bottom of the display.

7.7. 2D code



Scanning the 2D code with a smartphone will lead to the web page for ABB low voltage electronic relays and controls. On the page more information and details about the temperature monitoring portfolio as well as other related products can be found.

7.8. Factory reset



A factory reset sets the device back to the delivery condition. All personal settings and user profiles will be deleted. Maintenance counter and operating hours counter which cannot be deleted by the user will be kept even after a factory reset. To make a factory reset, click on the symbol.

Condition monitoring – factory reset



A confirmation pane will be displayed to ask again for confirmation. Confirmation will lead to a factory reset.

Condition monitoring – confirmation factory reset:

STATUS	SECURITY LEVEL	DOCUMENT ID.	REV.	LANG.	PAGE
Approved	Public	2CDC112285M0201	E	en	43/57



It is advised to conduct a factory reset before disposing of the device at the end-of-life.

7.9. Device information



In the device information page the name of the device, the order code, the serial number and the firmware version are displayed.

Device information:

	CM-TCN.0115 1SUR750740R0110 SN:052000000019 V 0.19.0
--	---

8. Modbus communication (only CM-TCN.012)

CM-TCN.012 supports the data transmission using the Modbus RTU communication protocol. The function is embedded in the temperature monitoring relay and does not require installation of any accessories.

The implementation of Modbus RTU in the CM-TCN.012 smart temperature monitoring relay is done according to the Modbus over Serial Line Specification and Implementation Guide V1.02 (<https://modbus.org/>).

8.1. Electrical installation

The CM-TCN.012 relay Modbus communication is provided by a “two-wire” electrical interface in accordance with EIA/TIA-485 standard. The third “common” conductor should also be connected to the relay.

CM-TCN.012 has output terminals for three signals:

- A: D0 receive/transmit, positive
- B: D1 receive/transmit, negative
- C: common connection.

STATUS	SECURITY LEVEL	DOCUMENT ID.	REV.	LANG.	PAGE
Approved	Public	2CDC112285M0201	E	en	44/57

Maximum number of devices, network length and wiring requirements are defined in the Modbus over Serial Line Specification and Implementation Guide V1.02.

Line termination is required to prevent signal reflections from the ends of the bus cable. The CM-TCN.012 relay is not equipped with internal bus termination. The recommended line termination resistance is 120 Ohm.

8.2. Modbus configuration

The Modbus setup can be done using the LCD and the push-rotate button, the EPiC smartphone app or the Modbus RTU communication bus if the device has already been configured using one of the first two methods. The user can set parameters for the device to communicate such as server address, baud rate, frame, and timeout.

Select the Modbus configuration menu:



By clicking on the communication symbol, the sub-menu is entered. The following parameters can be set:

Menu	Parameter	Sym- bol	Explanation	Data range
Modbus	Address	✉	The unique server ID	[1 ... 247] Default: 1
	Baudrate	📶	Data transmission speed	[1200, 2400, 4800, 9600, 19200, 38400, 57600, 115200] Default: 19200
	Frame	📏	Data length, parity and stop bit configuration	[8 Odd 1, 8 Even 1, 8 None 2, 8 None 1] Default: 8 Even 1
	Timeout	⌚	Maximum server response time. If exceeded, the device will indicate a communication error.	[0 ... 255 s] Default: 0 Timeout is disabled if [0 s] is selected.

8.3. Modbus RTU register map

8.3.1. Supported function codes

The following Modbus function codes are supported by CM-TCN.012:

Function code	Explanation
FC1	Read Coils
FC2	Read Discrete Inputs
FC3	Read Holding Registers
FC4	Read Input Registers
FC5	Write Single Coil
FC6	Write Single Register
FC16	Write Multiple Register

Parameters, diagnosis/maintenance and configuration data of the connected CM-TCN.012 devices can be accessed by applying the supported function codes on the addresses described in the following tables.

8.3.2. History and parameters reset, relays control.

Modbus access codes: FC1, FC2, FC5.

Modbus Address	Parameter	Type	Value/unit	Read/ Write	Min	Max	Default
0x0000	Bus signal 1 ¹⁾	Bit	0: Off 1: On	R/W	0	1	0
0x0001	Bus signal 2 ¹⁾	Bit	0: Off 1: On	R/W	0	1	0
0x0002	Bus signal 3 ¹⁾	Bit	0: Off 1: On	R/W	0	1	0
0x0003	Manual device reset	Bit	0: Off 1: On	R/W	0	1	0
0x0004	Factory reset	Bit	0: Off 1: On	R/W	0	1	0
0x0005	Reset trip counters	Bit	0: Off 1: On	R/W	0	1	0
0x0006	Clear event history	Bit	0: Off 1: On	R/W	0	1	0
0x0007	Reset Min/Max/Avg values	Bit	0: Off 1: On	R/W	0	1	0

1) This function works when it is activated in the relay assignment menu.

www.sazengostarsgp.com

@sazehgostar_paytakht

8.3.3. Status and measurements

Modbus access codes: FC3, FC4

Modbus Address	Parameter	Type	Value/unit	Read/write	Min	Max	Default
0x1000	Relay 1 state	Bit	0: Off 1: On	R	0	3	0
0x1001	Relay 2 state	Bit	2: On delay running 3: Off delay running	R	0	3	0
0x1002	Relay 3 state	Bit		R	0	3	0
0x1003	Sensor status channel 1	Bit[2]	0: OK 1: Out of range	R	0	3	0
0x1004	Sensor status channel 2	Bit[2]	2: Wire break 3: Short circuit	R	0	3	0
0x1005	Sensor status channel 3	Bit[2]		R	0	3	0
0x1006	Temperature or resistance value channel 1	Word	Depending on channel configuration:	R	Depending on channel configuration		
0x1007	Temperature or resistance value channel 2	Word	0.1 °C [-2000...+8500] 0.1 °F [-3280...+15620]	R			
0x1008	Temperature or resistance value channel 3	Word	0.1 Ohm [100...40100]	R			

8.3.4. Condition monitoring data: event history and timestamp

Modbus access codes: FC3, FC4

Modbus Address	Parameter	Type	Value/unit	Read/Write	Min	Max	Default
0x1010	Event history 0	Byte	0: No trip 1: Signal 1 2: Signal 2 3: Signal 3 4: Signal 4 5: Signal 5 6: Signal 6 7: Signal 7 8: Signal 8 9: Signal 9 10: Value out of range channel 1 11: Value out of range channel 2 12: Value out of range channel 3 13: Short circuit channel 1 14: Short circuit channel 2 15: Short circuit channel 3 16: Wire break channel 1 17: Wire break channel 2 18: Wire break channel 3 19: Cyclic function 1 20: Cyclic function 2 21: Cyclic function 3 22: Reserved 23: Reserved 24: Modbus timeout 25: Parameter out of range 26: Low voltage	R	0	26	0

Modbus Address	Parameter	Type	Value/unit	Read/Write	Min	Max	Default
0x1011, 0x1012	Timestamp of event history 0	Dword	[s] since Power-On Timestamp = -65535, if related event occurred before last Power-On	R	0	4.294.967.295	4.294.967.295
0x1013	Event history 1	Byte	Same as Event history 0	R	0	26	0
0x1014, 0x1015	Timestamp of event history 1	Dword	Same as Timestamp of event history 0	R	0	4.294.967.295	4.294.967.295
0x1016	Event history 2	Byte	Same as Event history 0	R	0	26	0
0x1017, 0x1018	Timestamp of event history 2	Dword	Same as Timestamp of event history 0	R	0	4.294.967.295	4.294.967.295
0x1019	Event history 3	Byte	Same as Event history 0	R	0	26	0
0x101A, 0x101B	Timestamp of event history 3	Dword	Same as Timestamp of event history 0	R	0	4.294.967.295	4.294.967.295
0x101C	Event history 4	Byte	Same as Event history 0	R	0	26	0
0x101D, 0x101E	Timestamp of event history 4	Dword	Same as Timestamp of event history 0	R	0	4.294.967.295	4.294.967.295
0x101F	Event history 5	Byte	Same as Event history 0	R	0	26	0
0x1020, 0x1021	Timestamp of event history 5	Dword	Same as Timestamp of event history 0	R	0	4.294.967.295	4.294.967.295
0x1022	Event history 6	Byte	Same as Event history 0	R	0	26	0
0x1023, 0x1024	Timestamp of event history 6	Dword	Same as Timestamp of event history 0	R	0	4.294.967.295	4.294.967.295
0x1025	Event history 7	Byte	Same as Event history 0	R	0	26	0
0x1026, 0x1027	Timestamp of event history 7	Dword	Same as Timestamp of event history 0	R	0	4.294.967.295	4.294.967.295
0x1028	Event history 8	Byte	Same as Event history 0	R	0	26	0
0x1029, 0x102A	Timestamp of event history 8	Dword	Same as Timestamp of event history 0	R	0	4.294.967.295	4.294.967.295
0x102B	Event history 9	Byte	Same as Event history 0	R	0	26	0
0x102C, 0x102D	Timestamp of event history 9	Dword	Same as Timestamp of event history 0	R	0	4.294.967.295	4.294.967.295

8.3.5. Condition monitoring data: operating hours counter, maintenance counter, statistics

Modbus access codes: FC3, FC4

Modbus Address	Parameter	Type	Value/unit	Read/Write	Min	Max	Default
0x1030, 0x1031	Time since power on	Dword	[s]	R	0	4.294.967.295	0
0x1032, 0x1033	Operating hours	Dword	[min]	R	0	4.294.967.295	0
0x1034, 0x1035	Operating hours relay 1	Dword		R	0	4.294.967.295	0
0x1036, 0x1037	Operating hours relay 2	Dword		R	0	4.294.967.295	0

Modbus Address	Parameter	Type	Value/unit	Read/Write	Min	Max	Default
0x1038, 0x1039	Operating hours relay 3	Dword		R	0	4.294.967.295	0
0x103A	Actual trip counter relay 1	Word		R	0	65535	0
0x103B	Actual trip counter relay 2	Word		R	0	65535	0
0x103C	Actual trip counter relay 3	Word		R	0	65535	0
0x103D, 0x103E	Trip counter relay 1	Dword		R	0	4.294.967.295	0
0x103F, 0x1040	Trip counter relay 2	Dword		R	0	4.294.967.295	0
0x1041, 0x1042	Trip counter relay 3	Dword		R	0	4.294.967.295	0
0x1043	Min. value channel 1	Word	Depending on channel configuration: 0.1 °C [-2000...+8500] 0.1 °F [-3280...+15620] 0.1 Ohm [100...40100]	R	Depending on channel configuration		
0x1044	Max. value channel 1	Word					
0x1045	Average value channel 1	Word					
0x1046	Min. value channel 2	Word					
0x1047	Max. value channel 2	Word					
0x1048	Average value channel 2	Word					
0x1049	Min. value channel 3	Word					
0x104A	Max. value channel 3	Word					
0x104B	Average value channel 3	Word					

8.3.6. Device configuration

Modbus access codes: FC3, FC4, FC6, FC16.

Modbus Address	Parameter	Type	Value/unit	Read/Write	Min	Max	Default
0x2100	Sensor type channel 1	Bit[4]	0: none 1: PT100 2: PT1000 3: NTC 4: PTC 5: Bimetal switch	R/W	0	5	1
0x2101	Sensor type channel 2	Bit[4]		R/W	0	5	1
0x2102	Sensor type channel 3	Bit[4]		R/W	0	5	1
0x2103	Reset function relay 1	Bit	0: Auto reset	R/W	0	1	0
0x2104	Reset function relay 2	Bit	1: Manual / Remote reset	R/W	0	1	0
0x2105	Reset function relay 3	Bit		R/W	0	1	0
0x2106	Operation principle relay 1	Bit	0: Open-circuit principle (NO)	R/W	0	1	1
0x2107	Operation principle relay 2	Bit	1: Closed-circuit principle (NC)	R/W	0	1	1
0x2108	Operation principle relay 3	Bit		R/W	0	1	1

Modbus Address	Parameter	Type	Value/unit	Read/Write	Min	Max	Default
0x2109, 0x210A	Relay 1 signal mapping	Dword	0: S1 1: S2 2: S3 3: S4 4: S5 5: S6 6: S7 7: S8 8: S9 9: Sensor error channel 1 10: Sensor error channel 2 11: Sensor error channel 3 12: Cyclic function 1 13: Cyclic function 2 14: Cyclic function 3 15: Bus signal 1 16: Bus signal 2 17: Bus signal 3 18: Bus Fault	R/W	0	262.143 (0x007F-FFFF)	7
0x210B, 0x210C	Relay 2 signal mapping	Dword		R/W	0	262.143 (0x007F-FFFF)	7
0x210D, 0x210E	Relay 3 signal mapping	Dword		R/W	0	262.143 (0x007F-FFFF)	7
0x210F	Signal S1	Byte	0: Ch1 Greater (Ch1 > ...) 1: Ch1 Less (Ch1 < ...) 2: Ch2 Greater (Ch2 > ...) 3: Ch2 Less (Ch2 < ...) 4: Ch3 Greater (Ch3 > ...) 5: Ch3 Less (Ch3 < ...) 6: Dif Ch1 Ch2 Greater 7: Dif Ch1 Ch2 Less 8: Dif Ch1 Ch3 Greater 9: Dif Ch1 Ch3 Less 10: Dif Ch2 Ch3 Greater 11: Dif Ch2 Ch3 Less	R/W	0	11	0
0x2110	Threshold S1	Word	Depending on channel configuration: 0.1 °C [-2000...8500] 0.1 °F [-3280...+15300] Read Only for PTC	R/W	Depending on channel configuration		
0x2111	Hysteresis S1	Word	Depending on channel configuration: 0.1 °C [10...999] 0.1 °F [18...1798] Read only for PTC	R/W	Depending on channel configuration		
0x2112	On Delay S1	Word	0.1s	R/W	0	65.535	0
0x2113	Off Delay S1	Word	0.1s	R/W	0	65.535	0
0x2114	Signal S2	Byte	Same as Signal S1	R/W	0	11	2

Modbus Address	Parameter	Type	Value/unit	Read/Write	Min	Max	Default
0x2115	Threshold S2	Word	Same as Threshold S1	R/W	Depending on channel configuration		
0x2116	Hysteresis S2	Word	Same as Hysteresis S1	R/W	Depending on channel configuration		
0x2117	On Delay S2	Word	0.1s	R/W	0	65.535	0
0x2118	Off Delay S2	Word	0.1s	R/W	0	65.535	0
0x2119	Signal S3	Byte	Same as Signal S1	R/W	0	11	2
0x211A	Threshold S3	Word	Same as Threshold S1	R/W	Depending on channel configuration		
0x211B	Hysteresis S3	Word	Same as Hysteresis S1	R/W	Depending on channel configuration		
0x211C	On Delay S3	Word	0.1s	R/W	0	65.535	0
0x211D	Off Delay S3	Word	0.1s	R/W	0	65.535	0
0x211E	Signal S4	Byte	Same as Signal S1	R/W	0	11	2
0x211F	Threshold S4	Word	Same as Threshold S1	R/W	Depending on channel configuration		
0x2120	Hysteresis S4	Word	Same as Hysteresis S1	R/W	Depending on channel configuration		
0x2121	On Delay S4	Word	0.1s	R/W	0	65.535	0
0x2122	Off Delay S4	Word	0.1s	R/W	0	65.535	0
0x2123	Signal S5	Byte	Same as Signal S1	R/W	0	11	2
0x2124	Threshold S5	Word	Same as Threshold S1	R/W	Depending on channel configuration		
0x2125	Hysteresis S5	Word	Same as Hysteresis S1	R/W	Depending on channel configuration		
0x2126	On Delay S5	Word	0.1s	R/W	0	65.535	0
0x2127	Off Delay S5	Word	0.1s	R/W	0	65.535	0
0x2128	Signal S6	Byte	Same as Signal S1	R/W	0	11	2
0x2129	Threshold S6	Word	Same as Threshold S1	R/W	Depending on channel configuration		
0x212A	Hysteresis S6	Word	Same as Hysteresis S1	R/W	Depending on channel configuration		
0x212B	On Delay S6	Word	0.1s	R/W	0	65.535	0
0x212C	Off Delay S6	Word	0.1s	R/W	0	65.535	0
0x212D	Signal S7	Byte	Same as Signal S1	R/W	0	11	2
0x212E	Threshold S7	Word	Same as Threshold S1	R/W	Depending on channel configuration		
0x212F	Hysteresis S7	Word	Same as Hysteresis S1	R/W	Depending on channel configuration		
0x2130	On Delay S7	Word	0.1s	R/W	0	65.535	0
0x2131	Off Delay S7	Word	0.1s	R/W	0	65.535	0
0x2132	Signal S8	Byte	Same as Signal S1	R/W	0	11	2
0x2133	Threshold S8	Word	Same as Threshold S1	R/W	Depending on channel configuration		
0x2134	Hysteresis S8	Word	Same as Hysteresis S1	R/W	Depending on channel configuration		
0x2135	On Delay S8	Word	0.1s	R/W	0	65.535	0
0x2136	Off Delay S8	Word	0.1s	R/W	0	65.535	0

Modbus Address	Parameter	Type	Value/unit	Read/Write	Min	Max	Default
0x2137	Signal S9	Byte	Same as Signal S1	R/W	0	11	2
0x2138	Threshold S9	Word	Same as Threshold S1	R/W	Depending on channel configuration		
0x2139	Hysteresis S9	Word	Same as Hysteresis S1	R/W	Depending on channel configuration		
0x213A	On Delay S9	Word	0.1s	R/W	0	65.535	0
0x213B	Off Delay S9	Word	0.1s	R/W	0	65.535	0
0x213C, 0x213D	Cyclic switching function 1: Cycle Time	Dword	Min	R/W	10	525.600	1440
0x213E, 0x213F	Cyclic switching function 2: Cycle Time	Dword		R/W	10	525.600	10080
0x2140, 0x2141	Cyclic switching function 3: Cycle Time	Dword		R/W	10	525.600	525600
0x2142	Cyclic switching function 1: On Time	Word	Min	R/W	1	1.440	10
0x2143	Cyclic switching function 2: On Time	Word		R/W	1	1.440	60
0x2144	Cyclic switching function 3: On Time	Word		R/W	1	1.440	360

8.3.7. Common settings

Modbus access codes: FC3, FC4, FC6, FC16

Modbus Address	Parameter	Type	Value/unit	Read/Write	Min	Max	Default
0x2000	Power on delay	Word	0.1s	R/W	20	9.999	30
0x2001	Display temperature unit	Bit	0: Celsius 1: Fahrenheit	R/W	0	1	0
0x2020	Modbus address	Byte		R/W	1	247	1
0x2021	Modbus baud rate	Bit[4]	0: 1.200 1: 2.400 2: 4.800 3: 9.600 4: 19.200 5: 34.800 6: 57.600 7: 115.200	R/W	0	7	4
0x2022	Modbus frame	Bit[2]	0: 8Data Odd 1Stop 1: 8Data Even 1Stop 2: 8Data No 2Stop 3: 8Data No 1Stop	R/W	0	3	1
0x2023	Modbus timeout	Byte	s	R/W	0	255	0

8.3.8. System information

Modbus access codes: firmware version – FC3, FC4; serial number – FC3, FC4, FC17.

Modbus Address	Parameter	Type	Value/unit	Read/Write	Min	Max	Default
0x401A	Firmware version high	Byte		R	0	255	0
0x401B	Firmware version low	Byte		R	0	255	0
0x401C	Firmware version release	Byte		R	0	255	0
0x4041, 0x4042	Serial_Number_0	Dword		R	0	4.294.967.295	0
0x4043, 0x4044	Serial_Number_1	Dword		R	0	4.294.967.295	0
0x4045, 0x4046	Serial_Number_2	Dword		R	0	4.294.967.295	0
0x4047, 0x4048	Serial_Number_3	Dword		R	0	4.294.967.295	0

سازه گستر پایتخت

تامین کننده ملزومات برق

الکترونیکال - مکانیکال - ابزار دقیق

۰۲۱-۶۶۱۷۲۰۳۲

www.sazehgostarsgp.com

@sazehgostar_paytakht

STATUS	SECURITY LEVEL	DOCUMENT ID.	REV.	LANG.	PAGE
Approved	Public	2CDC112285M0201	E	en	53/57

9. Error handling

Device behaviour	Solution
LED and display are OFF	The device is unpowered. Check the power supply connection to terminals A1-A2.
Display is ON, LED is alternating yellow/red	Parameter is out of range or parameters got corrupted: the device must be rebooted by disconnecting and reconnecting the power. All device settings must be checked to ensure correct configuration. Alternatively, a factory reset must be performed. After that, the user can set up the device from the beginning or write new or previously saved settings via NFC.
Display is OFF, LED is red	Device internal fault: the device must be rebooted by disconnecting and reconnecting the power. If the problem persists, the device needs to be replaced.
Display is ON, LED is blinking yellow	NFC Pairing Mode: It is active for 15 seconds to allow settings to be written/read via NFC and EPiC app.
Display is ON, LED is blinking red	Over- or undertemperature or sensor error. This is normal behaviour of the device. Check the trip information on bottom/status line of the display.
Display is ON, LED is permanently yellow	The cyclic function ON-time is active. This is normal behaviour of the device. Check the trip information on bottom/status line of the display.

سازه گستر پایتخت

تامین کننده ملزومات برق

الکترونیکال - مکانیکال - ابزار دقیق

۰۲۱-۶۶۱۷۲۰۳۲

www.sazehgostarsgp.com

@sazehgostar_paytakht

STATUS	SECURITY LEVEL	DOCUMENT ID.	REV.	LANG.	PAGE
Approved	Public	2CDC112285M0201	E	en	54/57

10. Software license information

Free Modbus library

A portable Modbus implementation for Modbus ASCII/RTU.

Copyright I 2006-2018 Christian Walter cwalter@embedded-solutions.at

All rights reserved.

Redistribution and use in source and binary forms, with or without modification, are permitted provided that the following conditions are met:

1. Redistributions of source code must retain the above copyright notice, this list of conditions and the following disclaimer.
2. Redistributions in binary form must reproduce the above copyright notice, this list of conditions and the following disclaimer in the documentation and/or other materials provided with the distribution.
3. The name of the author may not be used to endorse or promote products derived from this software without specific prior written permission.

THIS SOFTWARE IS PROVIDED BY THE AUTHOR "AS IS" AND ANY EXPRESS OR IMPLIED WARRANTIES, INCLUDING, BUT NOT LIMITED TO, THE IMPLIED WARRANTIES OF MERCHANTABILITY AND FITNESS FOR A PARTICULAR PURPOSE ARE DISCLAIMED. IN NO EVENT SHALL THE AUTHOR BE LIABLE FOR ANY DIRECT, INDIRECT, INCIDENTAL, SPECIAL, EXEMPLARY, OR CONSEQUENTIAL DAMAGES (INCLUDING, BUT NOT LIMITED TO, PROCUREMENT OF SUBSTITUTE GOODS OR SERVICES; LOSS OF USE, DATA, OR PROFITS; OR BUSINESS INTERRUPTION) HOWEVER CAUSED AND ON ANY THEORY OF LIABILITY, WHETHER IN CONTRACT, STRICT LIABILITY, OR TORT (INCLUDING NEGLIGENCE OR OTHERWISE) ARISING IN ANY WAY OUT OF THE USE OF THIS SOFTWARE, EVEN IF ADVISED OF THE POSSIBILITY OF SUCH DAMAGE.

11. Cyber security legal disclaimer

CM-TCN.012 is designed to be connected in the ABB and 3rd party products and communicate information data via Modbus RTU interface. It is the user's sole responsibility to provide and continuously ensure a secure connection between the product and the user's network or any other. The user shall establish and maintain any appropriate measures (such as but not limited to the installation of firewalls, application of authentication measures, encryption of data, installation of anti-virus programs, etc.) to protect the product, the network, its system, and the interface against any kind of security breaches, unauthorized access, interference, intrusion, leakage and/or theft of data or information. ABB and its affiliates are not liable for damages and/or losses related to such security breaches, any unauthorized access, interference, intrusion, leakage and/or theft of data or information. The data, examples and diagrams in this manual are included solely for the concept or product description and are not to be deemed as a statement of guaranteed properties. All people responsible for applying the equipment addressed in this manual must satisfy themselves that each intended application is suitable and acceptable, including that any applicable safety or other operational requirements are complied with. Any risks in applications where a system failure

STATUS	SECURITY LEVEL	DOCUMENT ID.	REV.	LANG.	PAGE
Approved	Public	2CDC112285M0201	E	en	55/57

and/or product failure would create a risk for harm to property or persons (including but not limited to personal injuries or death) shall be the sole responsibility of the person or entity applying the equipment, and those so responsible are hereby requested to ensure that all measures are taken to exclude or mitigate such risks. This document has been carefully checked by ABB, but deviations cannot be completely ruled out. In case any errors are detected, the reader is kindly requested to notify the manufacturer. Other than under explicit contractual commitments, in no event shall ABB be responsible or liable for any loss or damage resulting from the use of this manual or the application of the equipment.

Making your Networks more secure:

Following points are strongly recommended to make networks more secure:

1. **Isolate your network** – separate the OT network (operation technology) from the IT network (information technology). This helps prevent any attack reaching the IT network from spreading to the OT network.
2. **Use firewalls** – Implement firewalls to prevent unauthorized access to the OT network.
3. **Use access control** – Implement access controls to restrict the human and device access to the OT network.
4. **Keep software up to date** – Make sure all software/firmware of the devices are up to date to have the latest security updates installed.
5. **Reduce attack surface on devices** – Disable device functions, services and ports not needed.
6. **Replace default passwords** – Replace all default passwords of the devices to prevent at-tacker from getting access using default credentials.
7. **Monitor network activity** – Monitor the OT network for any malicious activities that could be a sign of an attack. Example of network monitoring tool is intrusion detection system (IDS).
8. **Train employees** – Train operators and service people on IT and OT security best practices.

الکتریکال – مکانیکال – ابزار دقیق

۰۲۱-۶۶۱۷۲۰۳۲

www.sazhegostarsgp.com

 @sazhegostar_paytakht

STATUS	SECURITY LEVEL	DOCUMENT ID.	REV.	LANG.	PAGE
Approved	Public	2CDC112285M0201	E	en	56/57

ABB STOTZ-KONTAKT GmbH
 Eppelheimer Strasse 82
 69123 Heidelberg
 Germany

You can find the address of your local sales organization on the ABB homepage.

S.G.P

سازه گستر پایتخت

تامین کننده ملزومات برق

Additional information

We reserve the right to make technical changes or modify the contents of this document without prior notices. With regard to purchase orders, the agreed particulars shall prevail. ABB AG does not accept any responsibility whatsoever for potential errors or possible lack of information in this document.

We reserve all rights in this document and in the subject matter and illustrations contained therein. Any reproduction, disclosure to third parties or utilization of its content – in whole or in parts – is forbidden without prior written consent of ABB AG. Copyright 2023 ABB

All rights reserved.

@sazehgostar_paytakht

PREPARED 2022-11-15	STATUS Approved	SECURITY LEVEL Public		
APPROVED 2022-11-15	DOCUMENT KIND Manual			
OWNING ORGANIZATION ABB STOTZ-KONTAKT GmbH	DOCUMENT ID. 2CDC112285M0201	REV. E	LANG. en	PAGE 57/57