

Fan coil room thermostat

RDF510, RDF530



سازہ گستر پائتخت

For 2-pipe and 4-pipe fan coil units

- LCD backlit display
- Keylock function
- Display either room temperature or setpoint
- Comfort and Protection(Off) operating modes
- Automatic or manual heating/cooling changeover
- Automatic or manual 3-speed fan control
- Fan and heating/cooling changeover symbol display (enable / disable)
- Fan and heating/cooling changeover functions (enable / disable)
- Selectable fan operation in deadzone
- Timer with delay Off function: preset or user selection from 1 to 23 hours
- Minimum and maximum setpoint limitation
- Return to previous operating mode, Protection or Comfort upon power down
- Internal sensor calibration
- Adjustable commissioning and control parameters
- Fit into 86x86 conduit boxes
- Three standard color variants are available: reference color codes are SILVER (Cool Grey 4C), GOLD (Gold 453C), BLACK (Pantone Black 7C)
- Customization is available

Use

To control the room temperature in individual rooms and zones that are:

- Heated or cooled with 2-pipe fan coil units (RDF510)
- Heated or/and cooled with 4-pipe fan coil units (RDF530)

The thermostats control:

- One 3-speed fan
- One or two on/off valve actuators

Functions

- Maintenance of room temperature via built-in temperature sensor
- Control sequence H/C selection (P01) or H/C manual changeover via button (P01=2)
- Operating mode selection via button
- Display either room temperature value or setpoint value (P06)
- Internal sensor calibration (P05)
- 3-speed fan control, automatic or manual mode selection via button
- Minimum and maximum setpoint limitation (P09&P10)
- Full or partial keylock (P14)
- Fan speed low or off in deadzone (P15)
- Display symbol and fan function of fan (P91)
- Display symbol and function of heating/cooling (P92)
- Reload factory settings for commissioning and control parameters (P71)
- On/Off output for 2-position valve or 3-wire (SPDT) valve actuator

Note: 3-wire valve is for RDF510 only

Advanced functions

- Timer with delay Off (P28)
- Fan minimum On-time (P59)
- Operating mode settings upon power down (P27)

Mechanical design

The thermostat consists of two parts:

- One LCD display and five key buttons on the user interface.
- One mounting plate for fitting onto a square conduit box with 60.3 mm fixed meters.

الکتریکال - مکانیکال - ابزار دقیق

۰۲۱-۶۶۱۷۲۰۳۲

www.sazehgostarsgp.com

@sazehgostar_paytakht

Operating and setting elements

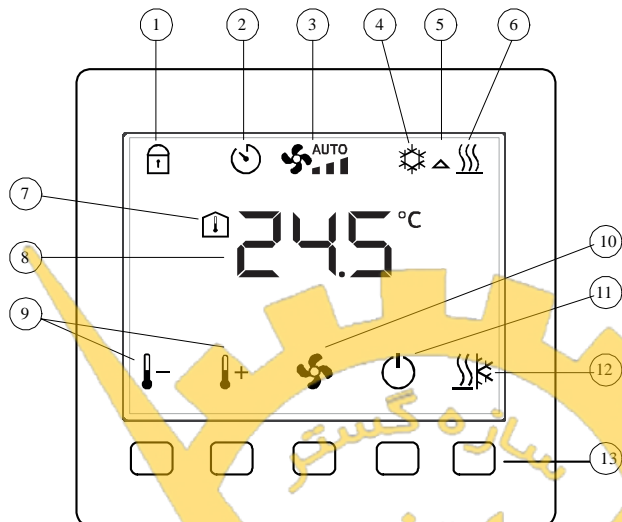

1. Keylock activated
2. Timer with delay Off mode
3. Auto fan, fan speed 1, 2, 3
4. Cooling mode selected
5. Valve output energized
6. Heating mode selected
7. Room temperature
8. Temperature value
9. Temperature setpoint adjustment
10. Fan mode selection
11. Operating mode selection: On, Off, timer with delay Off
12. Manual heating/cooling changeover
13. 5 key buttons to adjust setpoints (access control parameters), fan modes, operating modes, heating/cooling changeover

Type summary

Ordering





Type	Stock number	Designation
RDF510	S55770-T382	Room thermostat (White) in single pack of 1 unit
RDF510/BP	S55770-T383	Room thermostat (White) in bulk pack of 20 units
RDF510/BP.VS	S55770-T403	Room thermostat (Silver) in bulk pack of 20 units
RDF510/BP.VB	S55770-T404	Room thermostat (Black) in bulk pack of 20 units
RDF510/BP.VG	S55770-T405	Room thermostat (Gold) in bulk pack of 20 units
RDF530	S55770-T384	Room thermostat (White) in single pack of 1 unit
RDF530/BP	S55770-T385	Room thermostat (White) in bulk pack of 20 units
RDF530/BP.VS	S55770-T423	Room thermostat (Silver) in bulk pack of 20 units
RDF530/BP.VB	S55770-T417	Room thermostat (Black) in bulk pack of 20 units
RDF530/BP.VG	S55770-T424	Room thermostat (Gold) in bulk pack of 20 units

Delivery

Order valve actuators separately.

Equipment combinations

On/Off actuators

Type of units		Product number	Data sheet*)
Electromotive ON/OFF valve and actuator (only available in AP, UAE, SA and IN)		MVI.../MXI...	A6V11251892
Electromotive ON/OFF actuator		SFA21...	N4863
Thermal actuator (for radiator valve) AC 230 V, NO		STA23...	N4884
Thermal actuator AC 230 V (for small valves 2.5 mm), NC		STP23...	N4884
Zone valve actuators (only available in AP, UAE, SA and IN)		SUA...	N4832

*) All documents can be downloaded from <https://www.downloads.siemens.com/download-center/>.

Product documentation

Title	Document ID
Mounting and operating instructions	A6V10889954
CE declarations	A6V101090515
Environmental declarations	A5W00085405A

All the documents can be downloaded from <https://www.downloads.siemens.com/download-center/>.

Notes

Security

	⚠ CAUTION الکتریکال - مکانیکال - ابزار دقیق
	National safety regulations Failure to comply with national safety regulations may result in personal injury and property damage <ul style="list-style-type: none"> Observe any national provisions and comply with the appropriate safety regulations.

www.sazehgostarsgp.com

 @sazehgostar_paytakht

Mounting

Do not wall-mount in niches or bookshelves, behind curtains, above or near heat sources, wind outlets or inlets, and do not expose to direct solar radiation. Mount about 1.5 m above the floor.

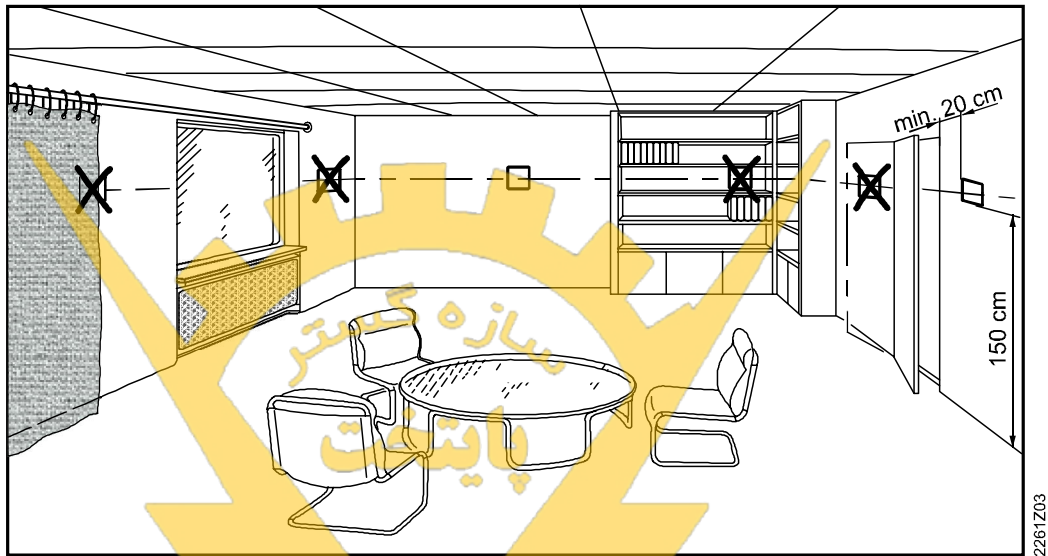

A mounting plate is provided for fitting onto a square conduit box with 60.3 mm fixed centers. A conduit box of at least 35–40 mm in depth to accommodate all wire connections is recommended.

After installing the mounting plate, wire all terminals of the thermostat. Secure the unit to the mounting plate as described in the installation and operating instructions (Document ID: A6V10889954) enclosed with the thermostat.



⚠ WARNING

Wire, protect and earth in compliance with local regulations.

Current loading is limited by a standard slow-blow 6.3 A fuse (replaceable).

Risk of fire and injury due to short-circuits!

- Adapt the line diameters as per local regulations to the rated value of the installed overcurrent protection device.
- The AC 230 V mains supply line must have an external circuit breaker with a rated current of no more than 10 A.
- The maximum current loading (including fan and valves) is 5 A.
- Use only valve actuators rated for AC 230 V.
- Disconnect from supply before removing the unit from its mounting plate.
- Do not connect more than one fan coil unit to the Qs output of the thermostat.
- Do not connect terminal Y12 to either L or N.
- Do not use terminal Y12 as AC 230 V power supply.

www.sazehgostarsgp.com

 @sazehgostar_paytakht

Commissioning

After powering up, the thermostat resets and all LCD segments light up for about 3 seconds. Afterwards, the room temperature is displayed (factory setting) and the unit is ready for commissioning by qualified HVAC staff.

The thermostat's control parameters can be adjusted to ensure optimum performance of the entire system (see "Parameter settings").

Surge protection at power-up

When the thermostats are powered up, LCD display and key buttons work normally except all valve and fan outputs, e.g., Q1, Q2, Q3, Y1, Y2, Y12, Y14.

The outputs of thermostats start up at random to protect the mains from overload. It may take up to two minutes *) before all outputs of thermostats work properly.

Note:

*) If the room thermostat uses the mains supply from a hotel Room Control Unit (RCU), less startup time (e.g. < 3 seconds) is more suitable for this type of hotel applications. Please add a special note to request for RDF510/RDF530 products with firmware revision D or above.

Sensor calibration

The thermostat has an internal sensor for accurate temperature display. If the temperature display is influenced by its installation location, calibrate the sensor via parameter P05 to adjust the readings.

Setpoint and range limitation

For comfort and energy saving reasons, we suggest to review the setpoints and setpoint ranges (parameters P09, P10, P65 and P66) and change them as needed.

Manual heating/cooling changeover

If the thermostat is enabled for "H/C changeover manual" via parameter P01=2 (factory setting for RDF510), press the "H/C changeover" button to display the currently selected control sequence on the LCD. Press again to change the control sequence. The newly selected control sequence is displayed and executed after the thermostat returns to On mode.

If the thermostat is set to "Cooling only" or "Heating only" via parameter P01, the manual changeover function is not available. Press the "H/C Changeover" button to display only the current control sequence on the LCD.

Control sequences

On/Off control

On 2-pipe applications, the thermostat controls an On/Off valve in heating/cooling mode with manual changeover (P01 = 2, factory set).

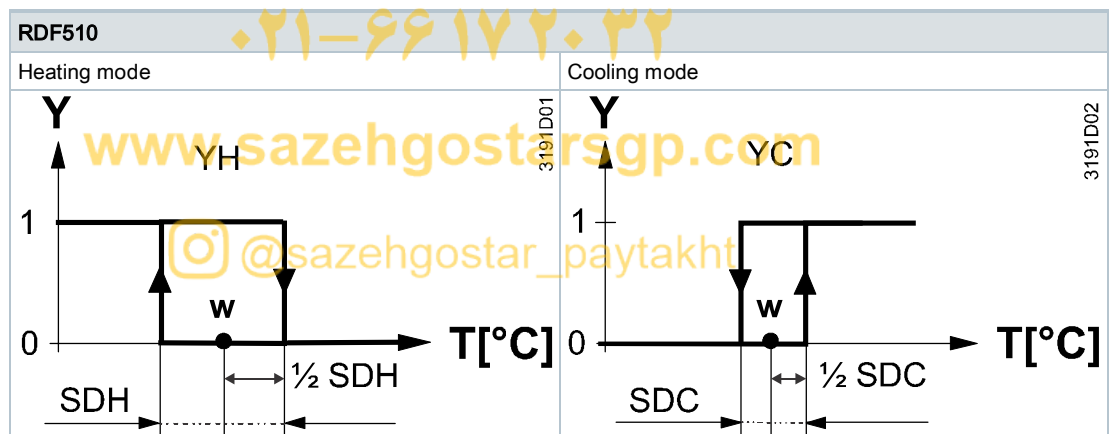

RDF510			
T[°C]	Room temperature	SDH	Switching differential "Heating"
W	Room temperature setpoint	SDC	Switching differential "Cooling"
YH	Control command "Valve" (heating)	YC	Control command "Valve" (cooling)

On 4-pipe applications, the thermostat controls two On/Off valves in heating and cooling mode (P01=4, factory set), or heating/cooling mode (P01=2) by manual changeover.

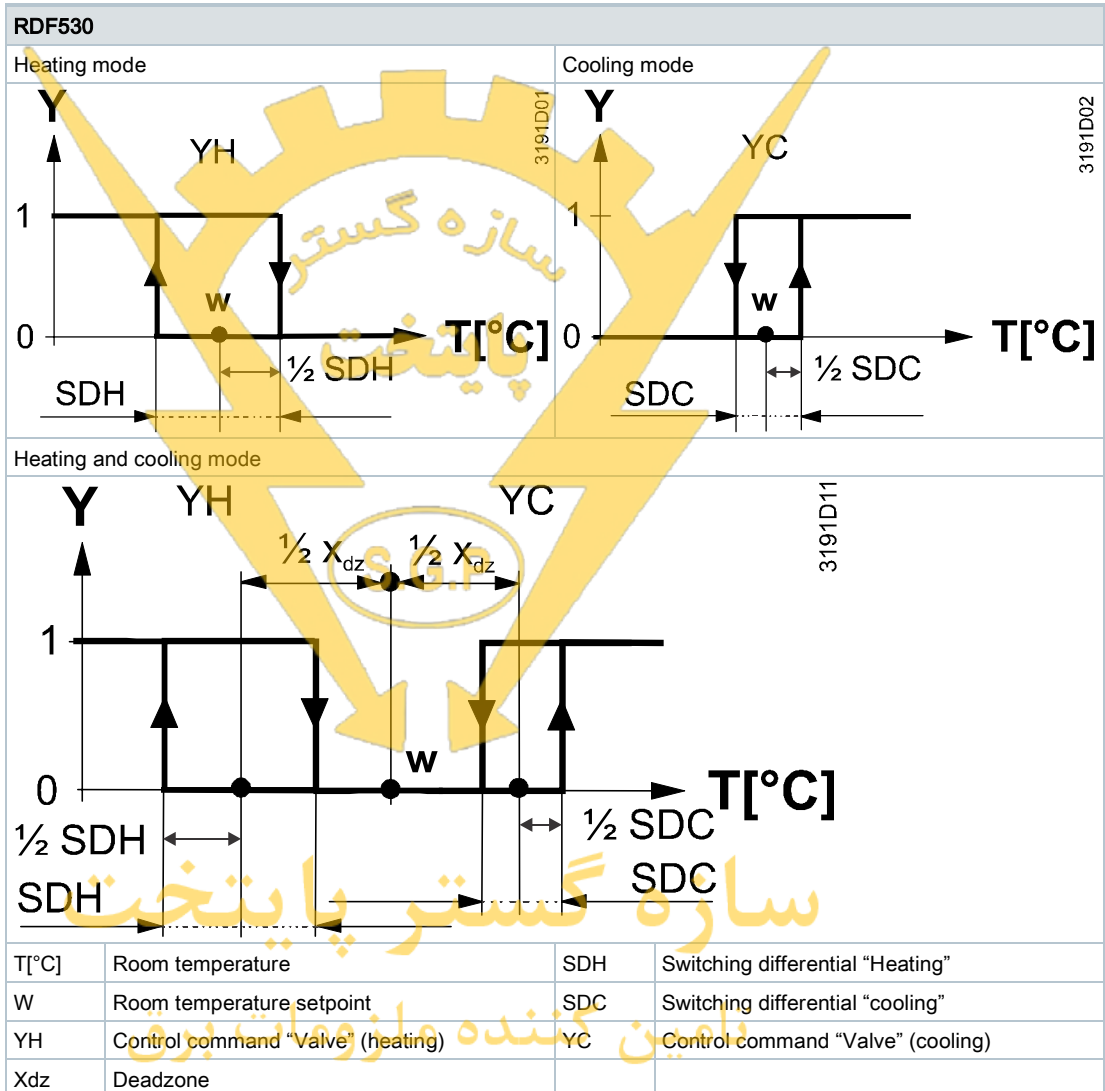

الکتریکال - مکانیکال - ابزار دقیق

On/Off control signal

The valve receives the On command via control output Y14 (Y1 and Y2 on RDF530) when:

1. The acquired room temperature is below the setpoint (for heating mode) or above the setpoint (for cooling mode), and
2. The control output was not energized for more than the "Minimum output off time" (factory setting 1 minute)

The valve receives the Off command when:

1. The acquired room temperature is above the setpoint (for heating mode) or below the setpoint (for cooling mode), and
2. The control output was energized for more than the "Minimum output on time"; (factory setting 1 minute)

Note:

- Control output Y12 delivers a control command which is inverted to the control command at output Y14 that can be used for normally open valves.
- Valve output can respond immediately and does not consider minimum On/Off time if users manually adjust the setpoint via local HMI.

Fan operation

The fan operates either in automatic mode or at the selected speed in manual mode.

In automatic mode, the fan speed depends on the setpoint and the current room temperature. When the room temperature reaches the setpoint, the control valve is closed and the fan either remains in fan speed 1 (P15=0) or switches off (P15=1).

In "Temperature-dependent" fan control, the fan switches off (see diagram below). The individual switching differentials of the fan speed 1, 2, 3 (Q1, Q2 and Q3) can be adjusted via control parameters P30 and P31.

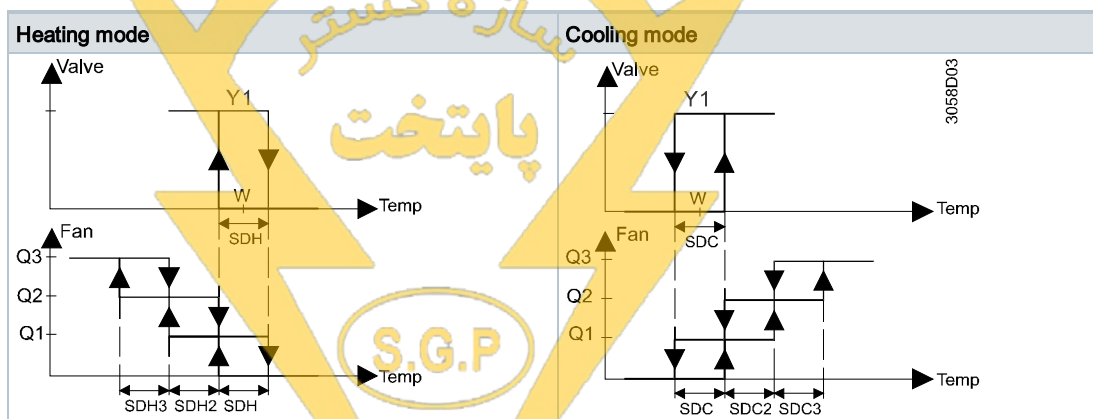

Ventilation always on

If desired, fan control can be set to "Temperature-independent", which means that ventilation is always on, even within the dead zone, using at least fan speed 1 (P15 = 1, factory set).

See "Avoiding damage due to moisture" for more information.

Fan minimum On-time

In automatic mode, a dwelling time of 2 minutes (factory setting) is active. The fan maintains that speed for at least 2 minutes before it switches to the next speed. This dwelling time can be adjusted from 1...6 minutes via parameter P59.

Fan On-time is set to minimum 2 minutes before the fan is turned off. This prevents the fan from being frequently switched between the On and Off states. The maximum duration is 6 minutes.

Fan start

When the fan starts from standstill, it starts at speed 3 for 1 second to guarantee safe fan motor start (to overcome inertia and friction).

Error handling

Temperature out of range

Factory setting of the heating/cooling setpoint in Protection mode is Off, i.e. overheating/frost protection is disabled.

In this case, when the room temperature is out of range, i.e. above 49 °C or below 0 °C, the temperature displays and flashes at "0 °C" or "49 °C", and the thermostat continues to work.

Sensor error

When the internal sensor is not working properly, "Er1" is displayed.

Parameter settings

To optimize control performance, use the local HMI to adjust a number of control parameters. All control parameter settings are retained after power down.

Proceed as follows to change the control parameters:

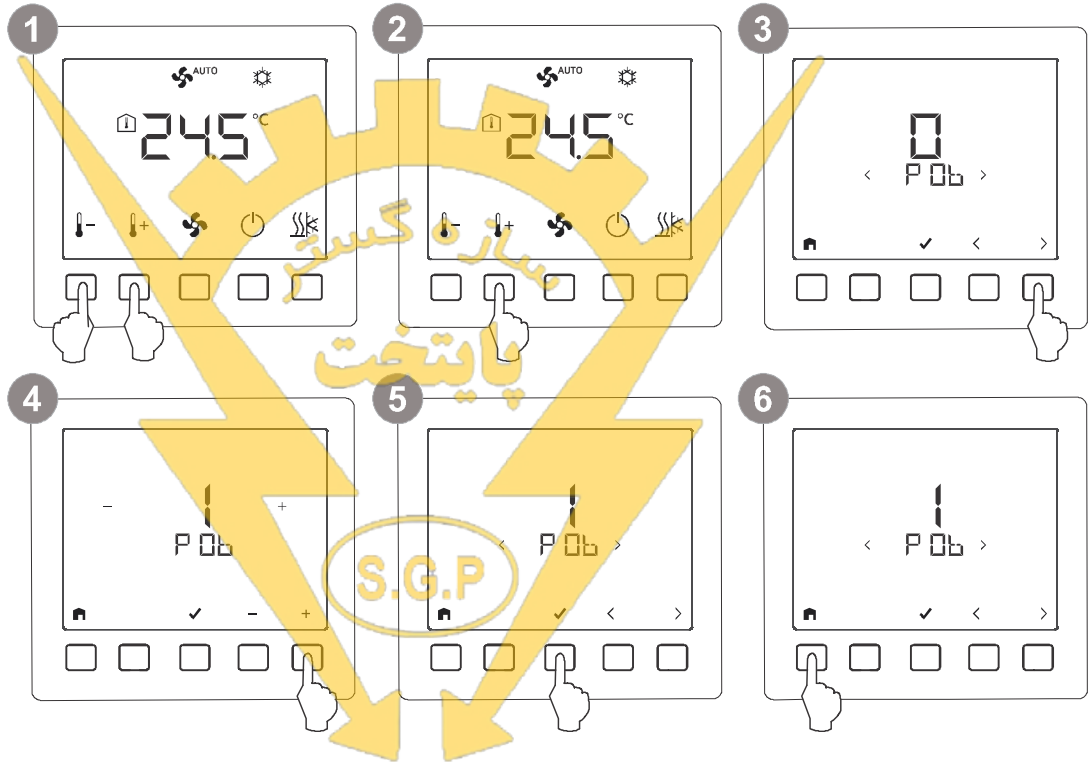

- 1 Press and hold down the + and - buttons simultaneously for more than 3 seconds.
- 2 Release the buttons, and within 2 seconds, press and hold down the + button for 3 seconds. P01 is displayed.
- 3 Press < or > to access the desired parameter and press the ✓ button. The current value of the selected parameter is displayed.
- 4 Press the + or - button to change the value.
- 5 Press the ✓ button to confirm the change, and repeat steps 3 to 5 to change more parameters.
- 6 Press 🏠 to exit the parameter setting mode.

Reload factory setting

- Select parameter P71 and set it to On.
- The factory settings of the control parameters are reloaded.
 - “- - -” is displayed on the screen while reloading.

Control parameters

Parameter	Description	Factory setting	Setting range
P01	Control sequence	RDF510 = 2 RDF530 = 4	0:= Heating only 1:= Cooling only 2:= H/C changeover manual 4:= Heating and cooling (RDF530) Note: RDF510: 0, 1, 2 RDF530: 2, 4
P05	Sensor calibration	0 K	-5...+5 K
P06	Standard temperature display	0	0:= Room temperature 1:= Setpoint
P09	Minimum setpoint in Comfort mode	5 °C	5...40 °C
P10	Maximum setpoint in Comfort mode	35 °C	5...40 °C
P14	Keylock function	0	0:= No lock 1:= Full lock 2:= Partial lock
P15	Fan control deadzone in Comfort mode	1	0:= Fan off 1:= Fan speed 1 in heating or cooling mode
P27	Operating mode settings upon power down	0	0:= Return to previous operating mode or user settings 1:= Protection mode 2:= Comfort mode
P28	Timer with delay Off	0	0:= Users to set on-time duration 1 to 23:= Preset with a fixed on-time in hours
P30	Switching differential in heating mode	1 K	0.5 ... 6 K
P31	Switching differential in cooling mode	1 K	0.5 ... 6 K
P33	Deadzone in Comfort mode	2 K	0.5 ... 5 K (RDF530)
P59	Fan minimum On-time (dwelling time)	2 minutes	1...6 minutes
P65	Protection heating setpoint	8 °C	OFF, 5 °C...Wcool _{pro} ; Wcool _{pro} =40°C max.
P66	Protection cooling setpoint	OFF	OFF, Wheat _{pro} ...40°C; Wheat _{pro} =5°C min.
P71	Reload factory setting	OFF	OFF:= Disable ON:= Reload start “---” is displayed for 3 seconds while reloading
P91 ¹⁾	Fan symbol display and function controls - associated key button function is disabled	RDF510 = 1 RDF530 = 1	0: disable display 1: enable display
P92 ¹⁾	H/C changeover symbol display and function controls - associated key button function is disabled	RDF510 = 1 RDF530 = 1	0: disable display 1: enable display

Notes:

1) For RDF510/RDF530:

- If P91 = 0 is selected, P15, P59 will not be accessible by users;
- If P92 = 0 is selected,
 - RDF510: P01 = 0 or 1, while the factory setting of P01 is 1 instead.
 - RDF530: P01 = 4 only

Temperature control

The thermostat acquires the room temperature via its built-in sensor and maintains the setpoint by delivering 2-position valve control commands.

The switching differential is 1 K in heating mode and 1 K in cooling mode (adjustable via parameters P30 and P31).

Display

The display shows the current room temperature or the setpoint of the current operating mode (adjustable via parameter P06). Factory setting is to display the current room temperature.

The heating symbol  or the cooling symbol  indicates the selected control sequence.

The triangle symbol indicates the relay output connected to the fan coil unit is energized.

Setpoint adjustment and limitations

The factory setting for the Comfort basic setpoint is 21 °C. The Comfort setpoint can be adjusted via the +/- buttons. For comfort or energy saving purposes, the setpoint setting range is limited to minimum (P09) and maximum (P10).

P09 < P10 (comfort concept)

If the minimum setpoint (P09) is set lower than the maximum setpoint (P10), both heating and cooling setpoints are adjustable between these two limits. The customer sets the desired setpoint and the thermostat controls the room temperature accordingly.

For 4-pipe applications, the selected Comfort setpoint is in the middle of the deadzone (P33). The unit stops to energize the heating/cooling outputs as soon as the room temperature reaches the deadzone.

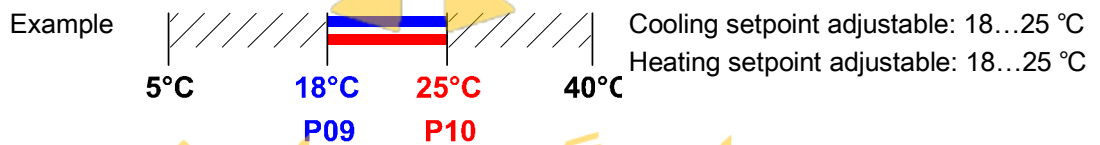

P09 ≥ P10 (energy saving concept)

If the minimum limit P09 is set higher than maximum limit P10, then:

- The setting range of cooling setpoint is P09...40 °C in place of 5...40 °C.
- The setting range of heating setpoint is 5 °C...P10 in place of 5...40 °C.

As a result, the maximum heating setpoint and the minimum cooling setpoint can be limited, thus saving energy and lowering costs.

For 4-pipe applications:

The thermostat runs with the setpoint of the active sequence:

- In heating mode, the heating setpoint is active and adjustable via buttons.
- In cooling mode, the cooling setpoint is active and adjustable via buttons.

Switching from heating to cooling setpoint and vice-versa occurs when the room temperature reaches the adjusted limitation (P09 or P10) of the inactive sequence. e.g. the thermostat is in heating sequence and runs on the heating setpoint. When the room temperature reaches P09, the thermostat switches to cooling mode and runs on the cooling setpoint, provided the room temperature does not drop below P10.

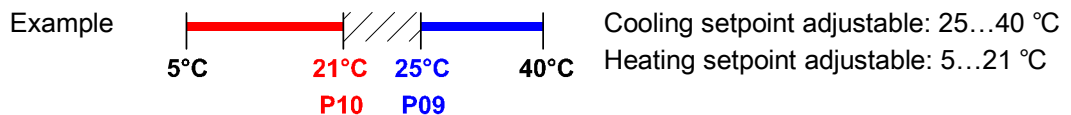

Keylock

Keylock can be activated or deactivated via parameter P14 when the thermostat is in Comfort and Protection mode.

Either full lock (P14=1) or partial lock (P14=2) can be selected. All buttons are disabled if full lock is set. On partial lock, only setpoints can be adjusted.

Operating modes

The following operating modes are available:

Comfort mode

In Comfort mode, the thermostat maintains the setpoint, which can be adjusted via the + and - buttons. The fan can be set to automatic or manual fan speed: Low, medium or high.



To save energy, the setpoint setting range has a minimum (P09) and maximum limitation (P10).

Protection mode

When the thermostat is in Protection mode, the related setpoints of heating or cooling setpoints are maintained. They can be adjusted via control parameters P65 and P66. The factory setting for P66 is OFF, indicating the thermostat is not active in Protection (cooling) mode.

Timer with delay Off mode

In timer with delay Off mode, the timer starts counting down according to the hour selected (via parameter P28) after the thermostat is turned ON. When the timer expires, the thermostat automatically turns OFF.

1. Activation of timer with delay Off mode

Timer with delay Off mode can be activated in two ways:

a) Parameter P28 = 0 (factory setting)

When P28 = 0, the delay timer is not active when the thermostat is powered up.

To activate the delay timer mode, please press and hold the button for more than 3 seconds.

b) Parameter P28 ≠ 0

When P28 ≠ 0, the delay timer is active in normal mode whenever the thermostat is turned on.

2. Setting of timer with delay Off mode

Refer to the Parameter settings.

3. Cancellation of timer with delay Off mode

Cancel by setting the timer to 0 hour.

Operating mode setting upon power down

If the thermostat is disconnected from AC 230 V power supply and then reconnected, the thermostat returns to the previous operating mode or user settings if P27=0, remains in Protection (Off) mode if P27=1, or remains in Comfort mode if P27=2.

Avoiding damage due to moisture

To avoid damage due to moisture in very warm and humid climates resulting from lack of air circulation in Comfort mode, the fan can be kept running at all times (e.g. in apartments or shops during unoccupied periods) when setting parameter P15 "ON in deadzone". In this case, the fan continues to run at minimum fan speed 1 in the neutral zone.

 @sazehgostar_paytakht

Disposal



The device is considered an electronic device for disposal in accordance with the European Guidelines and may not be disposed of as domestic garbage.

- Dispose of the device through channels provided for this purpose.
- Comply with all local and currently applicable laws and regulations.

Warranty

Technical data on specific applications are valid only together with Siemens products listed under "Equipment combinations". Siemens rejects any and all warranties in the event that third-party products are used.



سازه گستر پایتخت

تامین کننده ملزومات برق

الکتریکال - مکانیکال - ابزار دقیق

۰۲۱-۶۶۱۷۲۰۳۲

www.sazehgostarsgp.com

 @sazehgostar_paytakht

Technical data

Power supply	
Operating voltage	AC 230 V (+10%, -15%)
Frequency	50/60 Hz
Power consumption	Max. 12 VA

Internal fuse (replaceable)	
Fuse type	SLOW-BLOW
Size	dia. 5.2x20 mm
Voltage rating	250 V
Current rating	6.3 A

Outputs	
Valve output (RDF510) Y12 (N.C.)/Y14 (N.O.) Rating	AC 230 V 5 mA...4(2) A
Valve output (RDF530) Y1 (N.O.) /Y2 (N.O.) Rating	AC 230 V 5 mA...4(2) A
Fan output (3-speed fan) Q1, Q2, Q3 Rating	AC 230 V 5 mA...4(2) A

Operational data	
Switching differential	
- Heating mode	0.5...6 K (factory setting: 1 K)
- Cooling mode	0.5...6 K (factory setting: 1 K)
Setpoint setting range (see note below)	
- Comfort mode	5...40 °C
- Protection mode	OFF, 5...40 °C
Built-in room temperature sensor	
- Measuring range	0...50 °C
- Accuracy at 25 °C	< ±0.5 K
- Temperature calibration range	- 5.0...+5.0 K
Resolution of settings and display	
- Temperature setpoints	0.5 °C
- Current temperature value displayed	0.5 °C

Note: The standard range is 5...40 °C. Customization is available upon request (e.g. 0...50 °C).

Ambient conditions and protection classification	
Safety class	II as per EN 60730-1
Pollution class	II as per EN 60730-1
Degree of protection of housing	IP30 as per EN 60529
Climatic ambient conditions	
- Storage as per EN 60721-3-1	- Class 1K3
- Transport as per EN 60721-3-2	- Class 2K3
- Operation as per EN 60721-3-3	- Class 3K5 ¹⁾

1) No condensation is allowed.

Standards, directives and approvals	
EU conformity (CE)	A6V101090515
Environmental compatibility	The product environmental declaration (A5W00085405A) contains data on environmentally

Standards, directives and approvals	
	compatible product design and assessments (RoHS compliance, materials composition, packaging, environmental benefit, disposal).

All documentations can be downloaded from
<https://www.downloads.siemens.com/download-center/>.

General	
Connection terminals	Solid wires or prepared stranded wires: 1x0.4-1.5 mm ²
Weight	Mounting frame: 20 g RDF510 unit with mounting frame: 160 g RDF530 unit with mounting frame: 165 g
Color of front housing	White, RAL 9003 Silver, Cool Grey 4C Gold, Gold 453C Black, Pantone black 7C

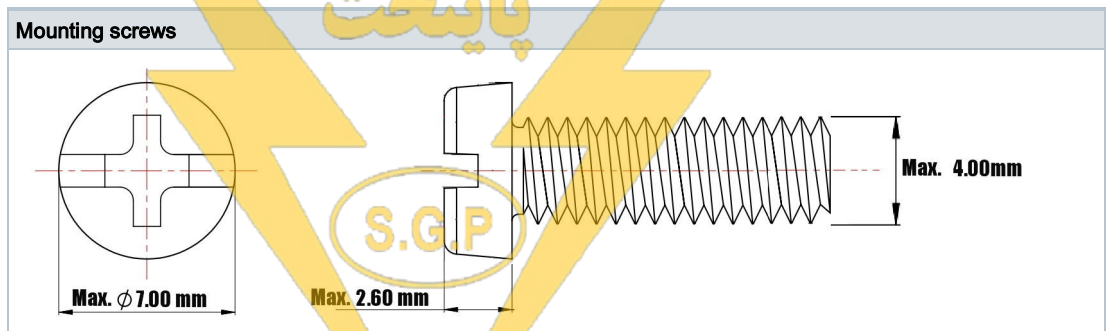

Diagrams

Connection terminals

RDF510		RDF530	
L, N	AC 230 V power supply, mains and neutral		
Q1	Output, fan speed 1, AC 230 V		
Q2	Output, fan speed 2, AC 230 V		
Q3	Output, fan speed 3, AC 230 V		
Y12	Output "Valve", AC 230 V (NC)		
Y14	Output "Valve", AC 230 V (NO)		
Y1	Output "Valve", AC 230 V (NO)		
Y2	Output "Valve" AC 230 V (NO)		

Connection diagrams

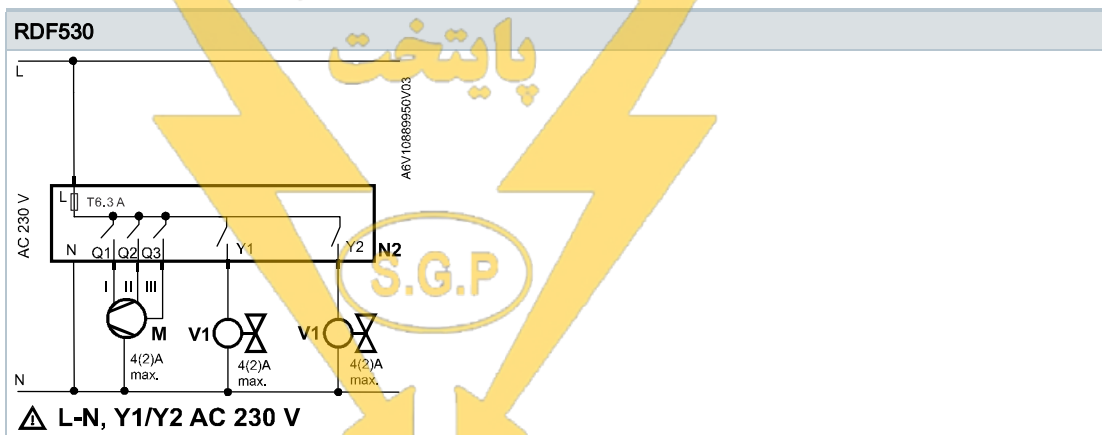
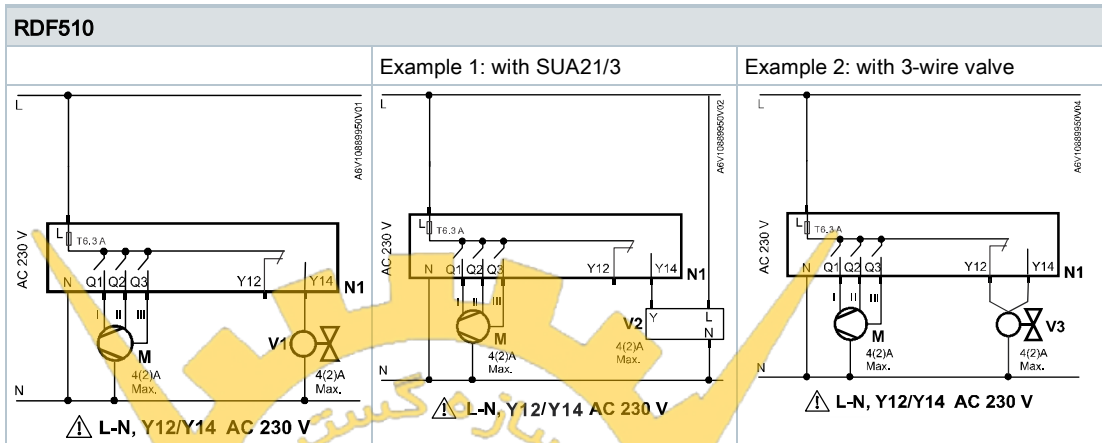

N1	RDF510
N2	RDF530
L, N	AC 230 V power supply, mains and neutral
Q1, Q2, Q3	SPST relay outputs for fan speed, low(Q1), medium(Q2), high(Q3)
M	3-speed fan motor
V1	On/Off valve
V2	On/Off valve: Siemens SUA21/3
V3	ON/Off valve: third party 3-wire valve
Y1, Y2	SPST relay output, normally open
Y12	SPDT relay output, normally closed - الکتریکال - مکانیکال - ابزار دقیق
Y14	SPDT relay output, normally open
T 6.3 A	Internal fuse (6.3 A), replaceable

۰۲۱-۶۶۱۷۲۰۳۲

www.sazehgostarsgp.com

@sazehgostar_paytakht

RDF510
 2-pipe fan coil unit
 ON / OFF (heating or cooling)

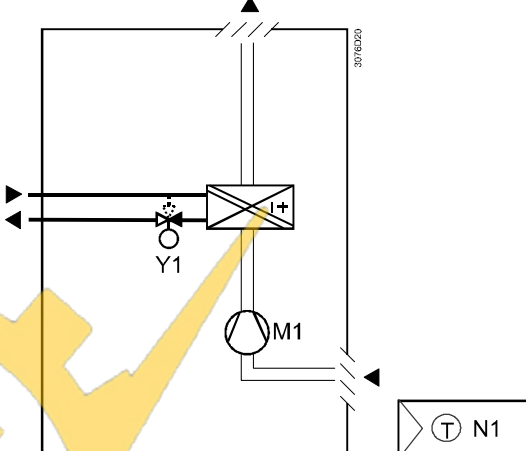

V1	Heating/cooling valve actuator
M1	3-speed fan
N1	RDF510

RDF530
 4-pipe fan coil unit
 ON/OFF (heating and cooling)

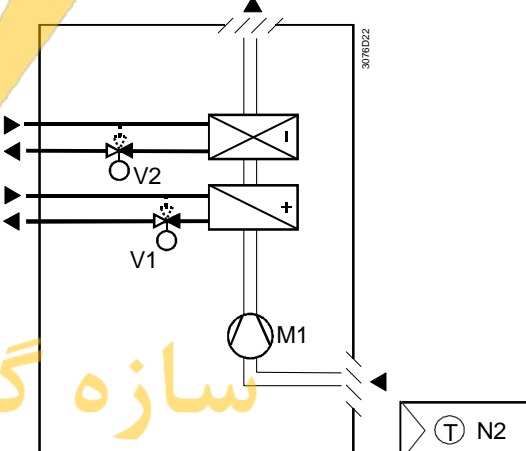

V1	Heating or heating/cooling valve actuator
V2	Cooling valve actuator
M1	3-speed fan
N2	RDF530

۰۲۱-۶۶ ۱۷ ۲۰ ۳۲

www.sazehgostarsgp.com

@sazehgostar_paytakht

Dimensions

Dimensions in mm
View A View B

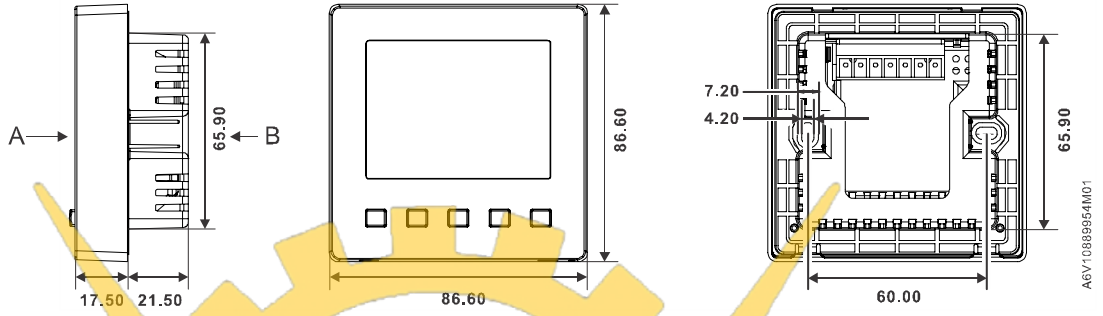

Above are the dimensions for the thermostat and its mounting plate.

سازه گستر پایتخت

تامین کننده ملزومات برق

الکتریکال - مکانیکال - ابزار دقیق

۰۲۱-۶۶ ۱۷ ۲۰ ۳۲

www.sazehgostarsgp.com

@sazehgostar_paytakht

Issued by
Siemens Switzerland Ltd
Smart Infrastructure
Global Headquarters
Theilerstrasse 1a
CH-6300 Zug
Tel. +41 58 724 2424
www.siemens.com/buildingtechnologies

© Siemens Switzerland Ltd, 2020
Technical specifications and availability subject to change without notice.